

HOME OF CLAMPING



2023/2024
VACUUM CLAMPING SYSTEMS

WE GENERATE EXCITEMENT.

Since the foundation of the company in 1890 until today the goal has remained the same: the highest quality in products and services. Nevertheless, the circumstances, tasks and challenges have changed, of course. By focussing on our core areas of expertise, we have long set new standards for innovative clamping technology - driven by our own development, the greatest possible flexibility and passion for individual solutions.

All this is only possible with committed and contented employees. Respectful interaction with others, personal development and measures for the wellbeing of each individual are therefore values that matter to us.



Company Management:
Wolfgang Balle, Johannes Maier (CEO), Jürgen Förster

OUR COMPANY HISTORY

- 1890 Company founded as a lock manufacturer by Andreas Maier.
- 1920 Product range extended to include spanners.
- 1928 Production line assembly of FELLBACH LOCKS.
- 1951 Introduces clamping elements and diversifies into workpiece and tool clamping technology.
- 1965 Toggle clamps extend the AMF product range, AMF catalogues are now printed in ten languages.
- 1975 Further specialisation into hydraulic clamping technology.
- 1982 Clamping and fixture systems round off AMF's clamping expertise.
- 1996 AMF team organisation in all sectors of the business, Quality management with certification to ISO 9001.
- 2001 AMF Service Guarantee for all products.
- 2004 Introduction of the ZPS zero-point clamping system.
- 2007 The magnetic clamping technology extends the AMF product range.
- 2009 Development and marketing of AMF Vacuum clamping technology.
- 2012 LOW-COST AUTOMATION gripping, clamping, marking and cleaning.
- 2014 AMF presents the most extensive product range of automation solution in zero-point clamping technology.
- 2017 Wireless sensing systems extend the expertise into Industry 4.0 and blends seamlessly into the AMF product range.

PLEDGES THAT COUNT IN EVERYDAY LIFE

For this reason, we have a few principles that we follow by conviction and which always apply.

INDIVIDUAL DEVELOPMENT

Even if the product you need does not even exist yet, we will find the right solution with you: from special designs to new developments, everything is possible.

WARRANTY

If, despite our high quality standard, there is a complaint, this is dealt with quickly and unbureaucratically, even beyond the warranty period.

HIGHEST QUALITY STANDARDS

Careful manufacturing based on tradition since 1890, and naturally with a modern quality management system according to ISO 9001 for many years.

SHORT DELIVERY TIME

With over 5,000 articles in our warehouse, you can expect your order to be dispatched on the same day.

COMPETENT SERVICE FROM EXPERTS

Your local retail partner or the specialists in our team will find the right solution for every task.

MADE IN GERMANY

Our entire product range is developed and manufactured exclusively by our employees in Germany.

<p>THE MOST IMPORTANT MATTER ON THE SUBJECT OF VACUUM CLAMPING TECHNOLOGY FROM AMF</p>	<p>4 - 5</p>
<p>AMF VACUUM CLAMPING PLATES</p>	<p>6 - 9</p>
<p>ADAPTER MAT, RUBBER ADAPTER PLATE, ALUMINIUM</p>	<p>10 - 11</p>
<p>SURFACE-MOUNTED BLOCK</p>	<p>12</p>
<p>ROTARY VANE VACUUM PUMP LIQUID SEPARATOR</p>	<p>13</p>
<p>ACCESSORIES</p>	<p>14 - 20</p>



THE MOST IMPORTANT ON THE SUBJECT OF VACUUM CLAMPING TECHNOLOGY

WHAT IS A VACUUM?

A vacuum is the state in a space which is free of matter. In practice, we already call it a vacuum when the air pressure in a space is less than that of the atmosphere.

UNITS OF MEASUREMENT USED

The most common units are the pascal and the bar.

- > 100 Pa = 1 hPa
- > 1 hPa = 1 mbar
- > 1 mbar = 0,001 bar

VACUUM CLAMPING SYSTEMS

Vacuum clamping systems are used above all in the wood, plastics and non-ferrous metals industries for quick, simple machining; they are compatible with CNC machine tools. Here vacuum technology is used in connection with special handling systems, for example in order to fix an aluminium plate and machine it from all sides. This increases productivity and cost-effectiveness: the fixing does not cause any damage to the workpiece, and no laborious, time-consuming aligning of the workpiece is required. The latest clamping systems allow attachments of various sizes and shapes to be exchanged in a very short time, thus facilitating flexible handling of a wide range of workpiece shapes.

WHAT DOES VACUUM CLAMPING MEAN?

In vacuum clamping, an underpressure is generated under the workpiece being clamped, i.e. a pressure differential is created which presses the workpiece against the clamping plate. Thus the workpiece is not, as one might think, actually „sucked,“ but is rather pressed against the vacuum table. The sliding force of the workpiece depends on its surface structure, the pressure differential and the area on which the vacuum acts. The larger this area is, the better the holding forces.

WHY DOES A VACUUM GENERATE A HOLDING FORCE?

All surfaces of an object are subjected to an even pressure of approx. 1 bar by the surrounding atmosphere. The integrated Venturi nozzle or an external vacuum pump then removes some of the air from under the workpiece being held, thus removing part of the pressure load on that surface. What remains is a one-sided pressure on the top surface of the workpiece, whose size depends on the degree of the vacuum. Generally it is 0.7 - 0.8 bar. This means, for example, that a vacuum of 200 mbar (absolute pressure) is generated. The pressure differential acting on the workpiece is therefore 800 mbar (approx. 0.8 kp/cm²). The size of the clamping force is then only dependent on the clamping area.

GENERAL INFORMATION

- > During workpiece machining, check the operating vacuum continually on a pressure gauge.
- > For heavy-duty cutting, always secure the workpiece with stops.
- > Only ever use sharp tools which are suited to the material being machined.
- > In particular with small machining areas, keep the machining forces as small as possible, e.g. through the use of small grinding diameters at high speeds.
- > Before workpiece machining, check that the workpiece is located securely.

FORMULA FOR DETERMINING THE RETAINING FORCE

- > Force (F) = Pressure (P) x area (A)

Example for order no. 564849 (400 mm x 600 mm) at 90% vacuum:

Vacuum plate 40 cm x 60 cm = 2400 cm²

Calculation of the retaining force (F) in Newtons (N):
2400 cm² (A) x 9,3 N/cm² (P) (pressure difference) = 22320 N

Conversion:

100 N ~ 10 kg

22320 N ~ 2230 kg retaining force (theoretical value)

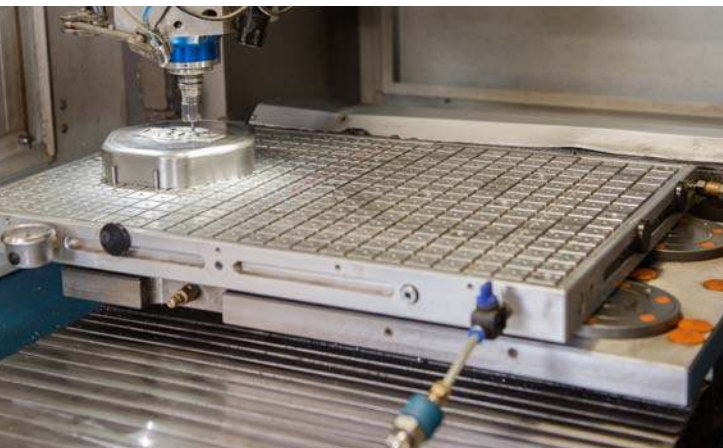

Relative vacuum [%]	Absolute residual pressure [bar]	[N/cm ²]	atm, [kp/cm ²]
60	0,4	-6,08	-0,62
70	0,3	-7,09	-0,723
80	0,2	-8,11	-0,827
90	0,1	-9,11	-0,93

THE BENEFITS OF AMF VACUUM CLAMPING TECHNOLOGY



1

> The AMF vacuum clamping plate can be operated using compressed air and the integrated Venturi nozzle, or with an external vacuum pump.

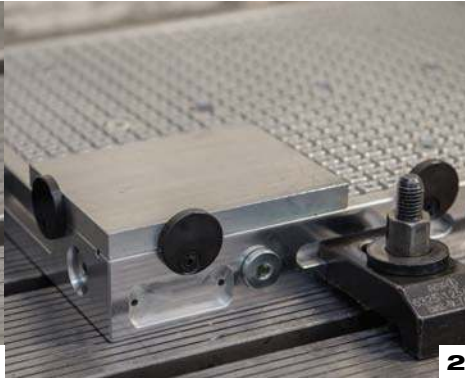

2

> The height-adjustable eccentric stops absorb the sliding forces, and can be adjusted individually to the workpiece height.

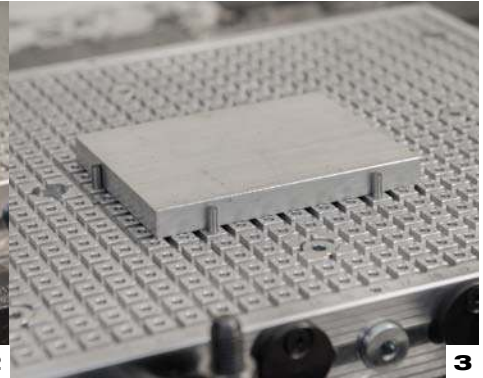

3

> Easy positioning of workpieces by fastening with stop pins. These also absorb the sliding forces.

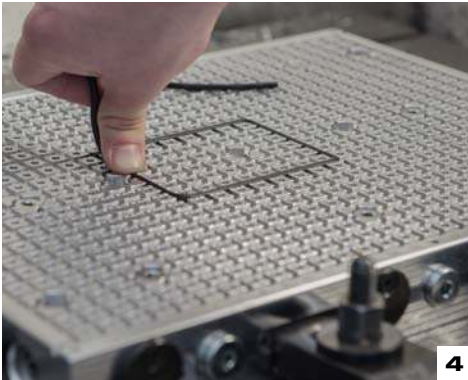

4

> Irregularities in the workpiece surface are compensated for by the sealing cord. The workpiece contour can be represented optimally using the grid pattern on the plate.

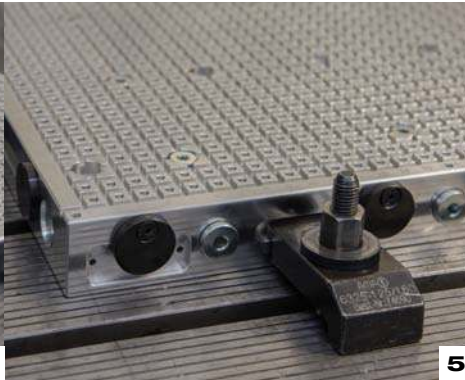

5

> Lateral grooves allow the vacuum clamping plate to be fastened to a baseplate or onto the machine table using AMF clamps (6325)

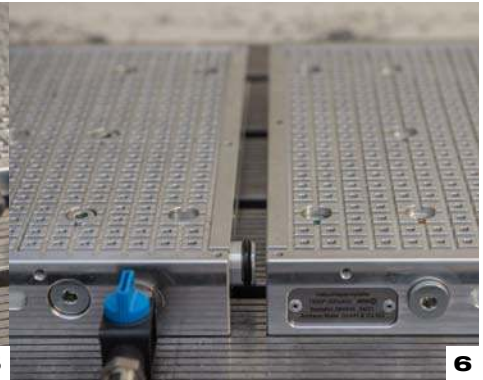

6

> Several vacuum clamping plates (7800P/7800PD) can be connected with the aid of our connecting piece (7800VVB).



7

> The compressed air escapes through the silencer of the vacuum clamping plate into the engine room. The sucked-in liquid (e.g. cooling lubricant) can also flow off through this.

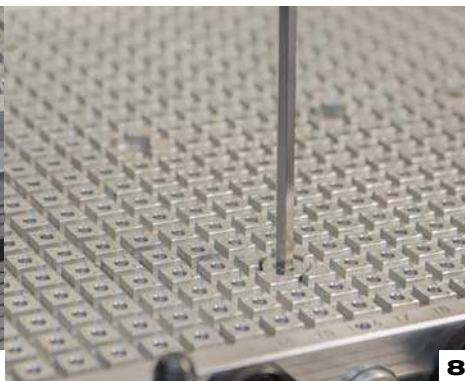

8

> Depending on the size of the clamping plate, workpieces can be clamped using more than one suction point. This can also be used to clamp multiple workpieces – even different ones.



9

> For efficient changing of the vacuum clamping plate (7800P/7800PD), it can be used in combination with the AMF „Zero-Point“ clamping system. This minimises setup times and increases machine runtime.

Nr. 7800PD

Vacuum clamping plate, Premium Diamond, diamond coating to increase the friction coefficient

NEW!



With connection-ready accessories.

Supplied as standard:

- Vacuum clamping plate made of aluminium with diamond coating
- Integrated Venturi nozzle
- Sound absorber
- Vacuum meter
- Shut-off valve
- Eccentric stops
- 2 m pneumatic hose
- Coupling connector for quick-release coupling
- Suction filter
- Threaded plugs
- 10 m sealing cord Ø 4 mm (black)
- 10 m sealing cord Ø 4 mm (grey)

Order no.	Operating pressure for max. vacuum [bar]	max. vacuum [%]	Number of suction points	Number of Venturi nozzles	A [mm]	B [mm]	H +0.15/-0.2 [mm]	Parallelism [mm]	R [mm]	Number of Zero-Point-Systems mounting holes	Weight [Kg]
568936	3,5	92	3	1	300	200	40	0,05	12,5	2	6,0
568939	3,5	92	9	1	300	400	40	0,05	12,5	4	12,0
568940	3,5	92	9	1	400	400	40	0,05	12,5	4	16,0

Design:

The vacuum clamping plate has grooves and suction points on its upper side. By inserting the sealing cord, one or more fields can be defined for the desired workpiece size. Simple positioning through lateral height adjustable eccentric stops.

Lateral grooves or fastening holes (for m8) allow the vacuum clamping plate to be fastened to a baseplate (e.g. machine table).

It is also no problem to integrate the vacuum clamping plate into the AMF size K20: M12 „clamping system size K20 (M12) (see the AMF catalogue „Zero-Point - Systems“). For use, we recommend a Ø 10 mm pneumatic hose (7800S).

These vacuum clamping plates have an additional diamond coating.

Application:

The workpieces being machined are clamped through generation of a vacuum by means of the integrated Venturi nozzle technology (included in scope of supply) or with an external vacuum pump. By means of individual grid allocation it is also possible to clamp and machine multiple, different workpieces at the same time.

Typical applications are milling and grinding operations.

Advantage:

- High holding forces, increased coefficient of friction due to diamond coating.
- The diamond coating significantly reduces the risk of the workpiece slipping, especially when wet machining with coolant.
- The AMF vacuum clamping plate can be operated using compressed air and the integrated Venturi nozzle, or with an external vacuum pump.
- The vacuum clamping plate is ready to use right away – all of the necessary components are included in the scope of supply.
- All suction points are interconnected.
- Cost savings through use of the Venturi nozzle.
- Low compressed air consumption, thus low operating costs.
Example: 1 m³ of compressed air costs 0.0078 €. At an average consumption of 49 l/min. this corresponds to 0.023 €/h.
- Multiple suction points, thus flexible grid allocation and clamping of multiple parts possible.
- Vacuum clamping plates can be combined with each other.
- Universal use.
- Sealing cords compensate for small irregularities in the workpiece surface.
- Distortion-free, vibration-free five-sided machining.

Note:

Operate only with dried, filtered, non-lubricated compressed air! Venturi nozzle can be used up to 60 °C.

Max. suction volume against atmosphere: 48,8 l/min.

Medium temperature: 0 °C - 60 °C

Ambient temperature: 10 °C - 50 °C

Please observe the installation manual.

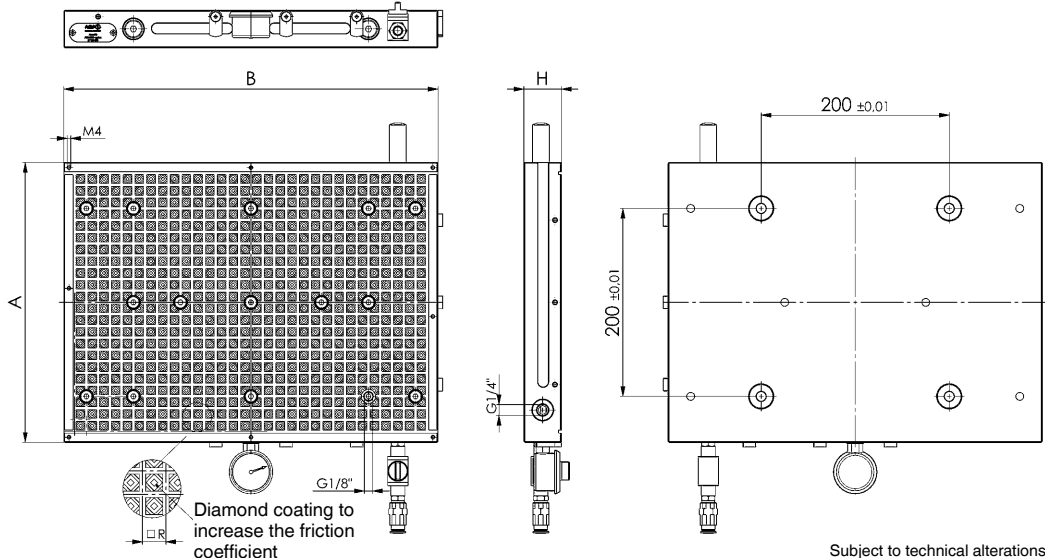

Subject to technical alterations.

No. 7800P

Vacuum clamping plate, Premium Line

With connection-ready accessories.

Supplied as standard:

- Vacuum clamping plate made of aluminium
- Integrated Venturi nozzle
- Sound absorber
- Vacuum meter
- Shut-off valve
- 6 eccentric stops
- 2 m pneumatic hose
- Coupling connector for quick-release coupling
- Suction filter
- Threaded plugs
- 10 m sealing cord Ø 4 mm (black)
- 10 m sealing cord Ø 4 mm (grey)



Order no.	Operating pressure for max. vacuum [bar]	max. vacuum [%]	Number of suction points	Number of Venturi nozzles	A [mm]	B [mm]	H +0.1/-0.2 [mm]	Parallelism [mm]	R [mm]	Number of Zero-Point-Systems mounting holes	Weight [Kg]
564844	3,5	92	1	1	150	150	40	0,05	12,5	-	1,0
564845	3,5	92	3	1	300	200	40	0,05	12,5	2	6,0
564846	3,5	92	9	1	300	400	40	0,05	12,5	4	12,0
564848	3,5	92	9	1	400	400	40	0,05	12,5	4	16,0
564849	3,5	92	10	1	400	600	40	0,05	12,5	6	24,0
563703	3,5	92	16	2	600	800	40	0,05	25,0	12	50,0

Design:

The vacuum clamping plate has grooves and suction points on its upper side. By inserting the sealing cord, one or more fields can be defined for the desired workpiece size. Easy positioning via holes for stop pins or lateral, height-adjustable eccentric stops.

Lateral grooves or fastening holes (for m8) allow the vacuum clamping plate to be fastened to a baseplate (e.g. machine table).

It is also no problem to integrate the vacuum clamping plate into the AMF zero-point clamping system size K20 (M12) through the existing locating holes (see the AMF catalogue „Zero-Point Systems“). For use, we recommend a Ø 10 mm pneumatic hose (7800S).

The vacuum clamping plate 563703 (600 x 800) is divided into two vacuum circuits and therefore has 2 x 6 mounting bores for the AMF zero-point clamping system. Thus, this is compatible with two 6-point clamping stations.

Application:

The workpieces being machined are clamped by generating a vacuum by means of the integrated Venturi nozzle technology (supplied as standard) or with an external vacuum pump. By means of individual grid allocation it is also possible to clamp and machine multiple, different workpieces at the same time. Typical applications are milling and grinding operations.

Advantage:

- The AMF vacuum clamping plate can be operated using compressed air and the integrated Venturi nozzle, or with an external vacuum pump.
- The vacuum clamping plate is ready to use right away – all of the necessary components are supplied as standard.
- All suction points are interconnected. (Exception: size 600 x 800 mm)
- With attaching thread M4 for fastening the adapter plate 7800APA.
- For the reproducibility of clamping, all grooves are labelled using a coordinate system.
- Stop bores Ø 4 mm for component positioning with stop pins.
- Cost savings through use of the Venturi nozzle.
- Low compressed air consumption, thus low operating costs.
Example: 1 m² of compressed air costs 0.0078 €. With an average consumption of 49 l/min. this corresponds to 0.023 €/h.
- Multiple suction points, thus flexible grid allocation and clamping of multiple parts possible.
- Vacuum clamping plates can be combined with each other.
- High holding forces.
- Universal use.
- Sealing cords compensate for small irregularities in the workpiece surface.
- Distortion-free and vibration-free five-side processing.

Note:

Operate only with dried, filtered, non-lubricated compressed air! Venturi nozzle useable up to 60 °C.

Max. Suction volume against atmosphere: 48.8 l/min.

Medium temperature: 0 °C - 60 °C

Ambient temperature: 10 °C - 50 °C

Please observe the installation instructions.

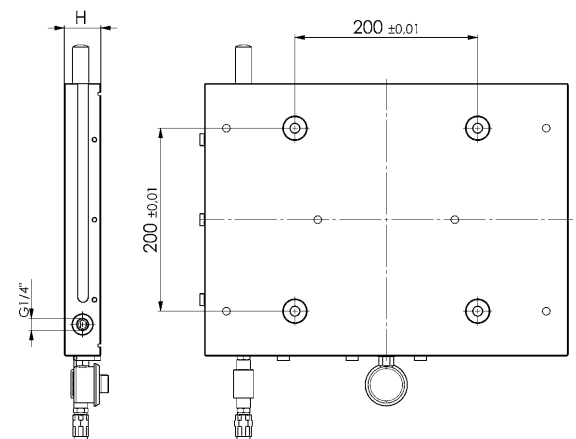
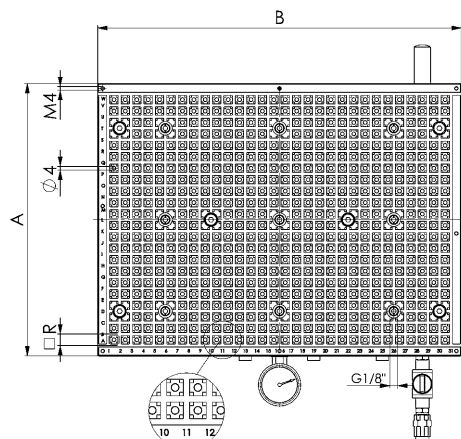
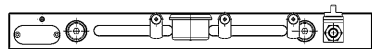

Subject to technical alterations.

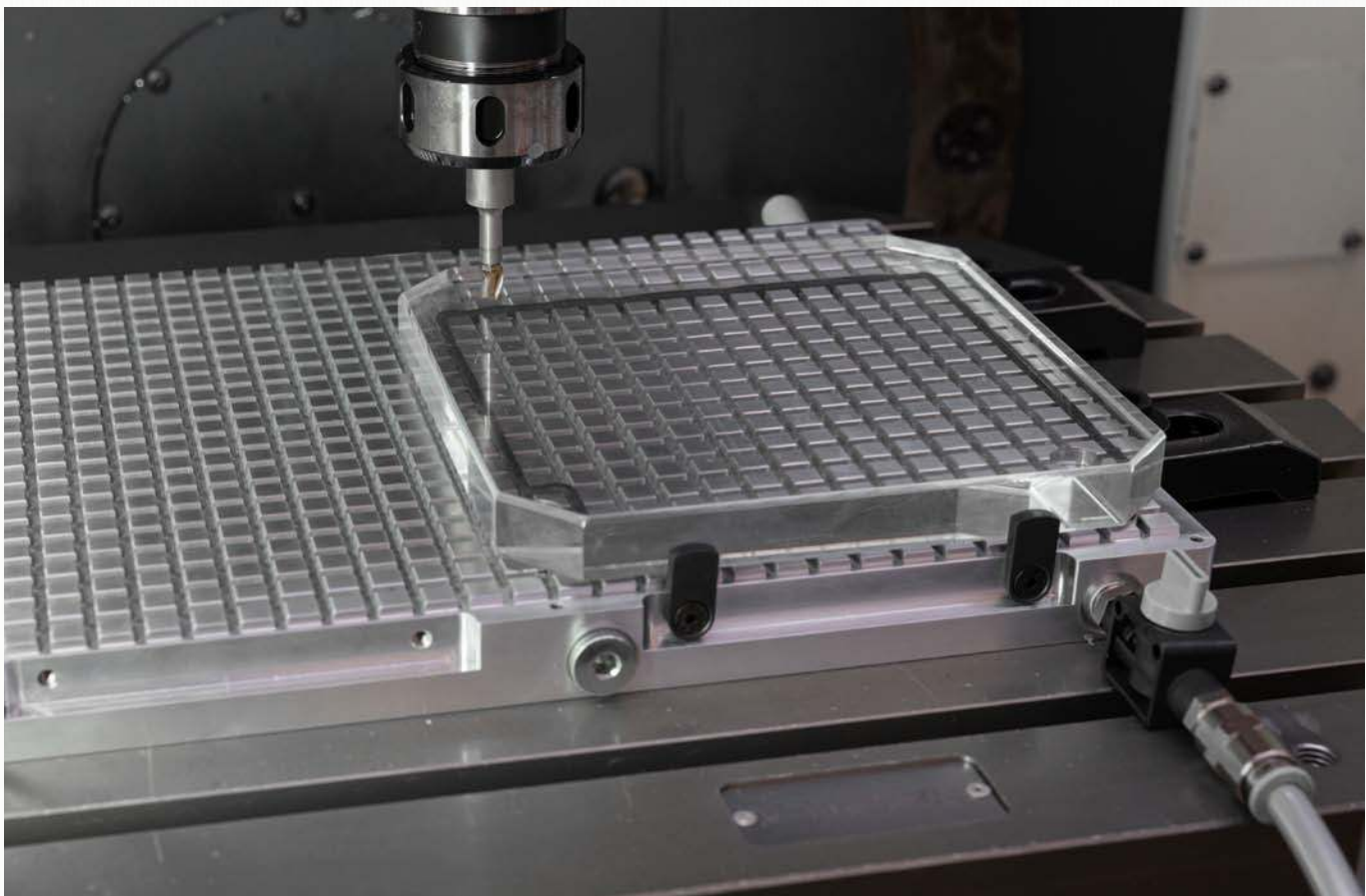
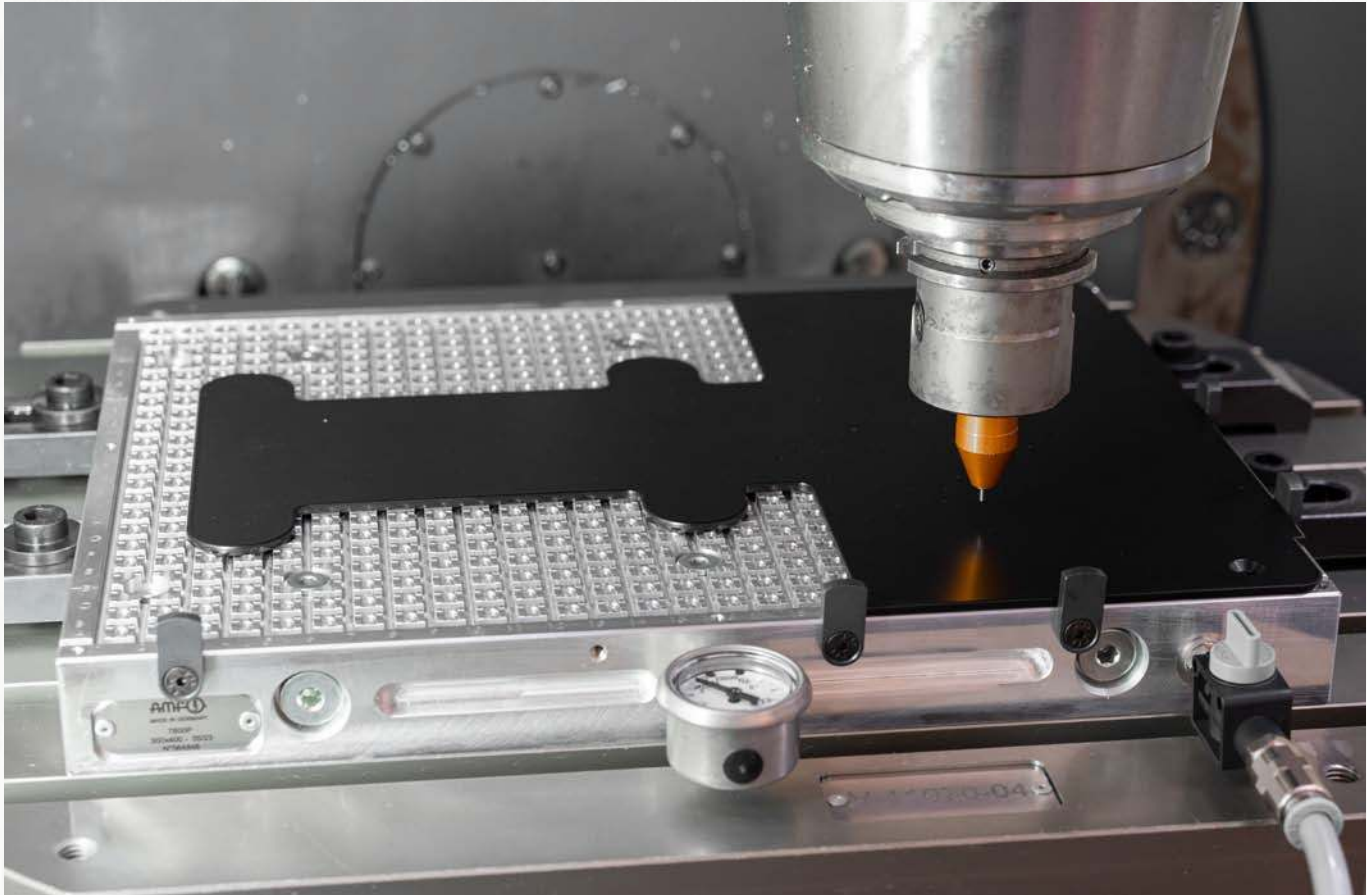

No. 7800BV

Vacuum clamping plate, Basic Line

NEW!

supplied as standard:

- Vacuum clamping plate made of aluminium
- Integrated Venturi nozzle
- Sound absorber
- Shut-off valve
- Eccentric stops
- Suction filter
- Threaded plugs
- 10 m sealing cord Ø4 mm (black)

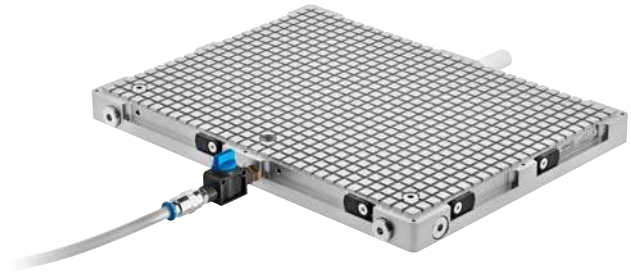

Order no.	Operating pressure for max. vacuum [bar]	max. vacuum [%]	Number of suction points	Number of Venturi nozzles	A [mm]	B [mm]	H +0.1/-0.2 [mm]	Parallelism [mm]	R [mm]	Weight [Kg]
569353	3,5	92	2	1	190	290	30	0,1	12,5	4,1
569354	3,5	92	3	1	290	390	30	0,1	12,5	8,5
569355	3,5	92	3	1	390	390	30	0,1	12,5	11,5
569356	3,5	92	5	1	390	590	30	0,1	12,5	17,3

Design:

The vacuum clamping plate has grooves and suction points on its upper side. By inserting the sealing cord, one or more fields can be defined for the desired workpiece size. Simple positioning through lateral eccentric stops.

With lateral clamping rim for fastening the vacuum clamping plate to a base plate (e.g. machine table). Subsequent holes for ZPS K10 (M8) are possible. Bore plans available on request. For use, we recommend a Ø 10 mm pneumatic hose (7800S).

Application:

The workpieces being machined are clamped through generation of a vacuum by means of the integrated Venturi nozzle technology (included in scope of supply) or with an external vacuum pump. Typical applications are milling and grinding operations.

Advantage:

- The AMF vacuum clamping plate can be operated using compressed air and the integrated Venturi nozzle, or with an external vacuum pump.
- By means of individual grid allocation it is also possible to clamp and machine multiple, different workpieces at the same time.
- High holding forces.
- Universal use.
- Sealing cords compensate for small irregularities in the workpiece surface.
- Distortion-free, vibration-free five-sided machining.

Note:

Operate only with dried, non-lubricated compressed air!
 Medium temperature: 0 °C - 60 °C
 Ambient temperature: 10 °C - 50 °C
 Please observe the installation manual.

On request:

Special dimensions are possible.

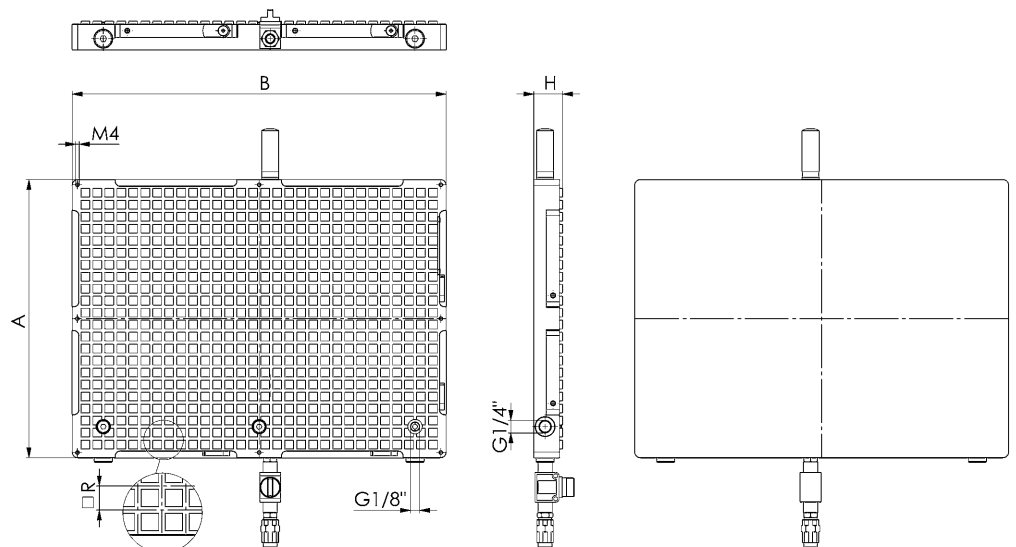

No. 7800AMG

Adapter mat, rubber

Material: Soft PVC.



CAD

Order no.	Dimension [mm]	Material thickness ± 0.3		Weight [g]
		[mm]		
375485	150x150	4		110
375014	300x200	4		275
375022	300x400	4		550
375030	400x400	4		780
375048	400x600	4		1100
NEW! 569485	600x800	4		2500

Application:

1. The sealing cord is placed in the grid of the vacuum clamping plate. It goes up to the end of the area to be worked on in the workpiece.
2. The adapter mat is placed onto the vacuum clamping plate.
3. Holes are made in the adapter mat within the marked clamping surface over a wood plate with a 3-5 mm diameter hole punch. The location of the holes must be in the area of the grid cuts of the vacuum clamping plate.
4. The workpiece to be worked on is placed on it and fixed using the adjustable eccentric stops.

Advantage:

- The good coefficient of friction offers especially good resistance against the displacement forces that arise during processing.
- The adapter mat can be cut into up to 2 mm deep without problem.
- If the same contours are used, the adapter mat can be reused almost any number of times, since it does not undergo wear.

Note:

Before wet machining with a cooling lubricant, the adapter mat should be cleaned with acetone.

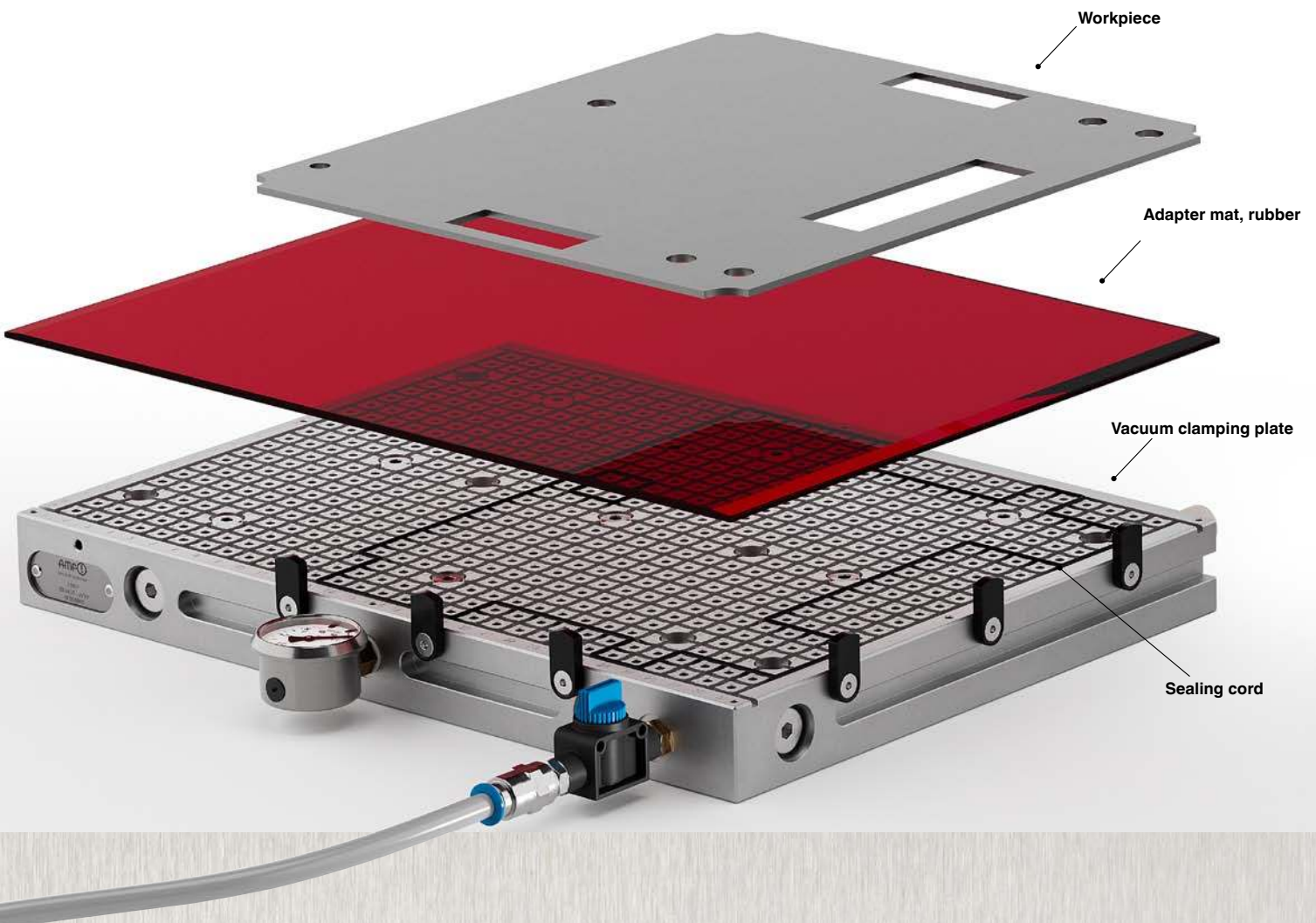

Subject to technical alterations.

No. 7800APA

Adapter plate, aluminium



Order no.	Dimension [mm]	Material thickness ±0.1 [mm]	Weight [Kg]
375097	150x150	10	0,6
374876	300x200	10	1,6
374892	300x400	10	3,3
374900	400x400	10	4,4
374918	400x600	10	6,6
563567	600x800	10	12,8

Application:

1. The sealing cord is placed in the grid of the vacuum clamping plate. It goes up to the end of the area to be worked on in the workpiece.
2. The adapter plate is screwed to the vacuum clamping plate.
3. The workpiece to be worked on is placed on it.
4. The workpiece is fixed using the adjustable eccentric stops.

Advantage:

- The adapter plate can be overcut by up to 2 mm (elimination of cuts).
- Preferred uses are for processing thin sheet metal, foils, boards and even paper.

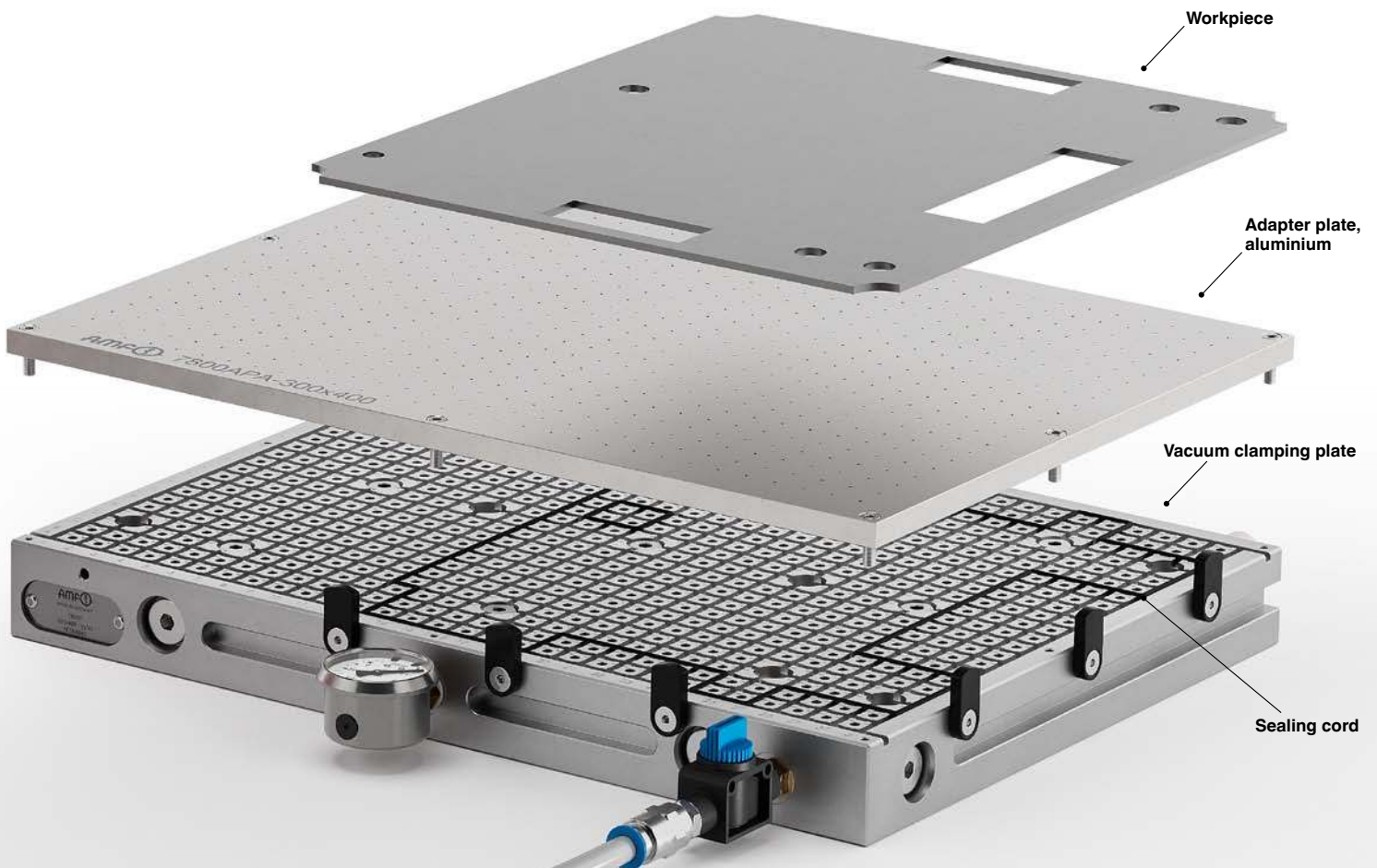

No. 7810AB

Surface-mounted block

- The following are supplied as standard:
- Surface-mounted block from aluminium, grid 12.5 x 12.5 mm
 - 3 eccentric stops with fixing screws
 - 1 m sealing cord Ø 2.0 mm



Order no.	max. vacuum [%]	Number of suction points	L	B	H	Weight [g]
375626	92	1	78	78	40	600

Design:

The surface-mounted block has grooves and a suction point on its upper side. The grid spacing is 12.5 mm. The field size is individually defined by inserting the sealing cord. The surface-mounted block is placed directly over a suction point on the vacuum clamping plate 7800P/7800BV. The underside is equipped with a sealing cord Ø 2.0 mm.

Application:

The use of surface-mounted blocks allows openings for finishing. Workpieces can be through-bored without the vacuum clamping plate or the component itself being damaged.

Note:

Please order sealing cord Ø 4.0 mm separately (Order no. 374512).

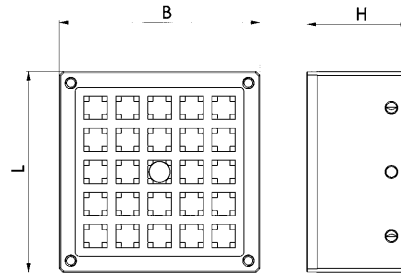

No. 7810APA

Adapter plate, aluminium

Suitable for surface-mounted block no. 7810AB.



Order no.	Dimension [mm]	Material thickness ±0.1 [mm]	Weight [g]
427930	78 x 78	10	200

Advantage:

- The good coefficient of friction offers particularly favourable resistance to the resulting displacement forces during finishing.
- Milling down to 2 mm deep in the adaptermat is no problem.
- If the same contours are always applied, the adapter mat can be reused any number of times, since they do not suffer any wear.



No. 7810AMG

Adapter mat, rubber

Material: Soft PVC.
Suitable for surface-mounted block 7810AB.



Order no.	Dimension [mm]	Material thickness ±0.3 [mm]	Weight [g]
375642	78 x 78	4	60

Advantage:

- The adapter plate can be milled down to 2 mm (millings on both sides).
- Preferred applications are the finishing of thin sheets, foils, PCBs and even paper.



No. 7800VP

Rotary vane vacuum pump

- Included in scope of supply:
- suction-side fine-mesh filter
 - oil mist separator
 - anti-vibration buffer
 - initial oil fill



Order no.	Suction performance [m³/h]	Output pressure mbar (absolute)	Motor rating [V/Hz]	Motor power [kW]	Noise level [dB (A)]	Ingress protection	Continuous operation [%]	L x W x H [mm]	Weight [Kg]
563547	20	1,5	230/50	0,75	65	54	100	320 x 230 x 220	21

Design:

Vacuum connection $\varnothing = 20$ mm

Application:

If there is no compressed air at the place of use of the vacuum clamping plate, we recommend using the AMF rotary vane vacuum pump. It guarantees reliable continuous operation of the clamping plates used. Thanks to the compact design of the pump, it can be installed directly on your machine.

Note:

Replacement oil can be ordered under order no. 428722.
Oil filling quantity 0.45 l.

On request:

Other sizes and suction performances are available on request.

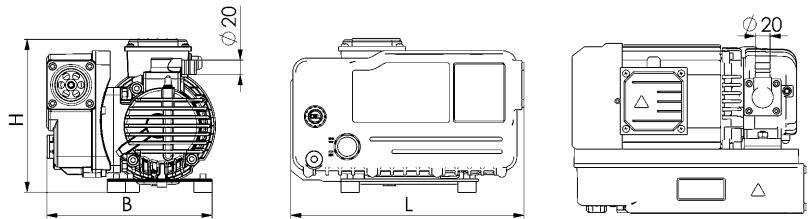

No. 7800VPF

Liquid separator

- included in scope of supply:
- Water separator
 - Vacuum filter
 - Fastening unit
 - Ball valve
 - Coupling plug 1/2" external thread - 15 mm
 - Plastic tube $\varnothing 15 \times 12$ mm, length 2 m
 - Coupler socket
 - Double nipple



Order no.	Size	Connection	Flow [m³/h]	Weight [g]
374975	D100x250	3/4"	15	1610

Application:

The liquid separator effectively removes condensate (water) from the vacuum clamping system and so protects it from contamination.

Advantage:

- Removal of 99% of the contained liquid
- maintenance-free
- system's operation and maintenance costs are minimised
- easy to install (before the vacuum pump)

Note:

The set is supplied in the assembled state.

Example of assembly:

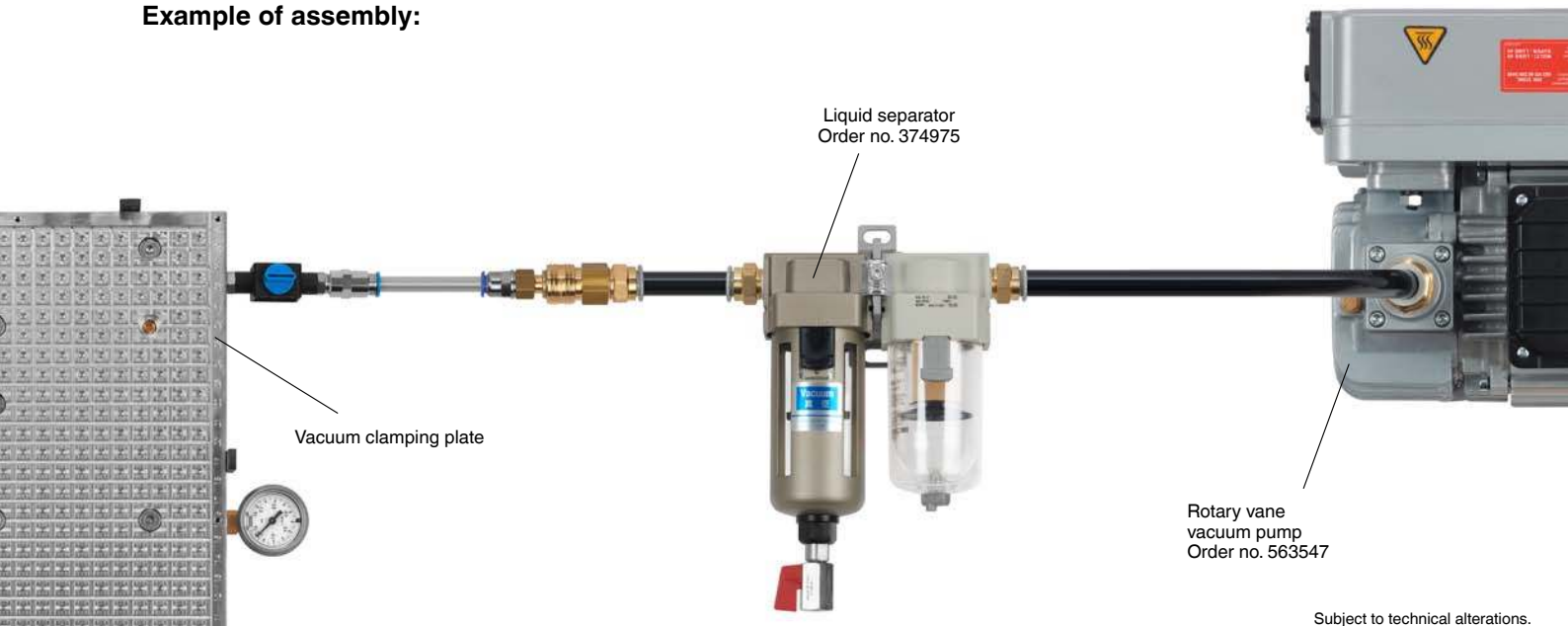

Subject to technical alterations.

Nr. 7800VPE-10-K

Venturi nozzle connecting set

Supplied as standard:

- vacuum creator, external
- pneumatic hose, outside Ø 10 mm, length: 10 m
- coupling connector for quick-release coupling

NEW!



Order no.	max. vacuum [%]	Max. suction volume flow [l/min.]	Operating pressure for max. vacuum [bar]	Vacuum connection Outside dia. [mm]	Pneum. connection Outside dia. [mm]	Weight [g]
567156	92	48,8	3,5	10	10	860

Design:

Complete connection set with external vacuum creator, pneumatic hose, coupling connector for quick-release coupling.

Application:

Connection set for easy connection of the vacuum clamping plate to the compressed air system.

Advantage:

Complete set, small size, universally usable and economical.

No. 7800VDR

Pressure control valve

Supplied as standard:

- 2 coupling plugs, I-form

NEW!



Order no.	Vacuum connection Outside dia. [mm]	Ambient temp. [°C]	Operating pressure for max. vacuum [bar]	B x H x T	Weight [g]
567157	10	-10 ... 60	3,5	114 x 94 x 76	400

Design:

Pressure regulating valve with coupling plugs for pneumatic hose 7800S-10.

Application:

Ballast for use on AMF vacuum clamping plates (7800BV/7800P/7800PD).

Advantage:

The operating pressure for maximum vacuum on the vacuum clamping plate is kept constant.

Note:

- Operation only with dried and filtered compressed air (compressed air in accordance with ISO8573-1: 2010)
- rotary knob with retainer
- pressure regulation range: 0.5 - 12 bar
- temperature of medium: -10°C ... 60°C
- installation position: any

No. 7800D

Sealing cord



Order no.	Design	Colour black	Colour grey	dia. [mm]	Length [m]	Material EPDM	Material NBR	Weight [g]
374512	S	●	-	4	10	●	-	320
563167	G	-	●	4	10	-	●	320

Design:

Black:

- universal use
- for wet and dry processing
- particularly suitable for thin workpieces

Grey:

- particularly suitable for dry processing

Application:

The sealing cord is inserted in the groove to delimit the clamping surface. Do not cut them off so that they are flush but let the cut ends overlap a little and push against one another. Please avoid stretching or compression of the caulking strip.

Advantage:

Multiple workpieces can be clamped, even with different sizes.

Note:

Apply the caulking strip closely to penetrations and recesses, in order to minimize tension force losses. Use in temperature range 0 °C to 90 °C.

Application image:

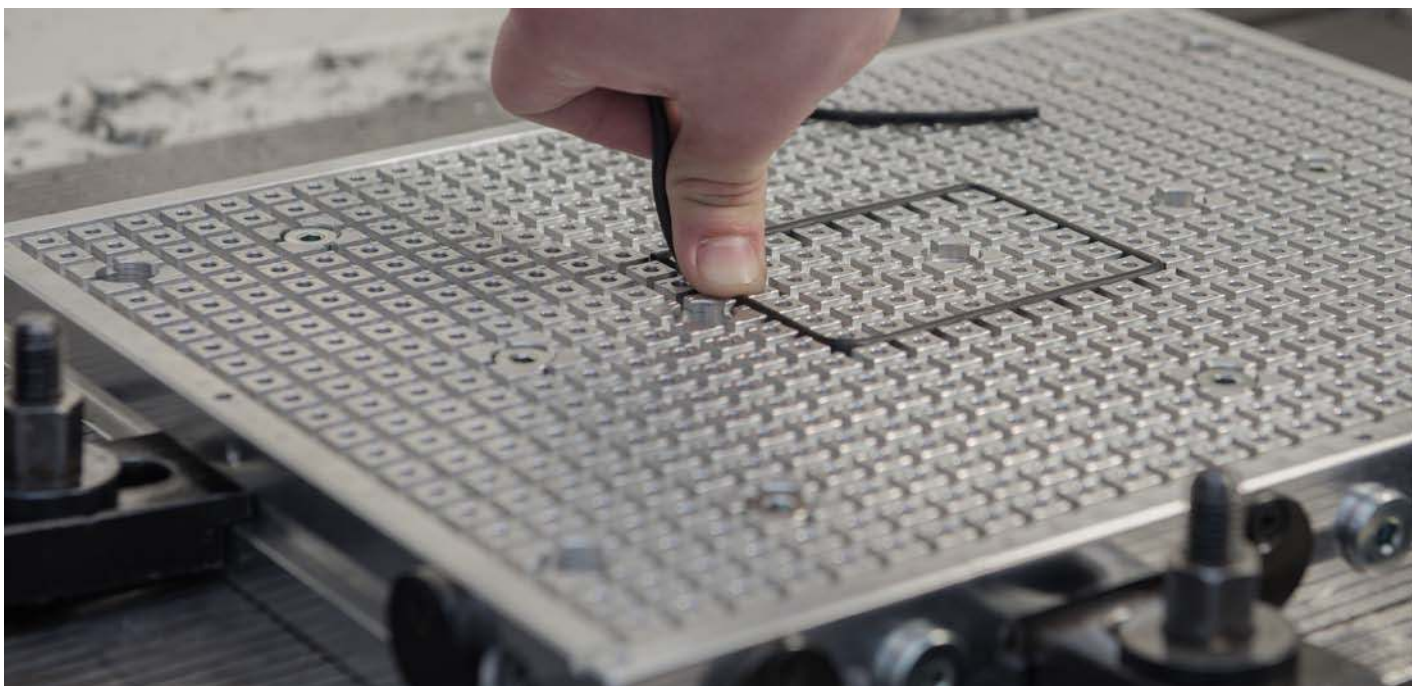
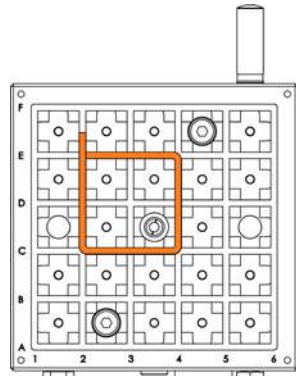

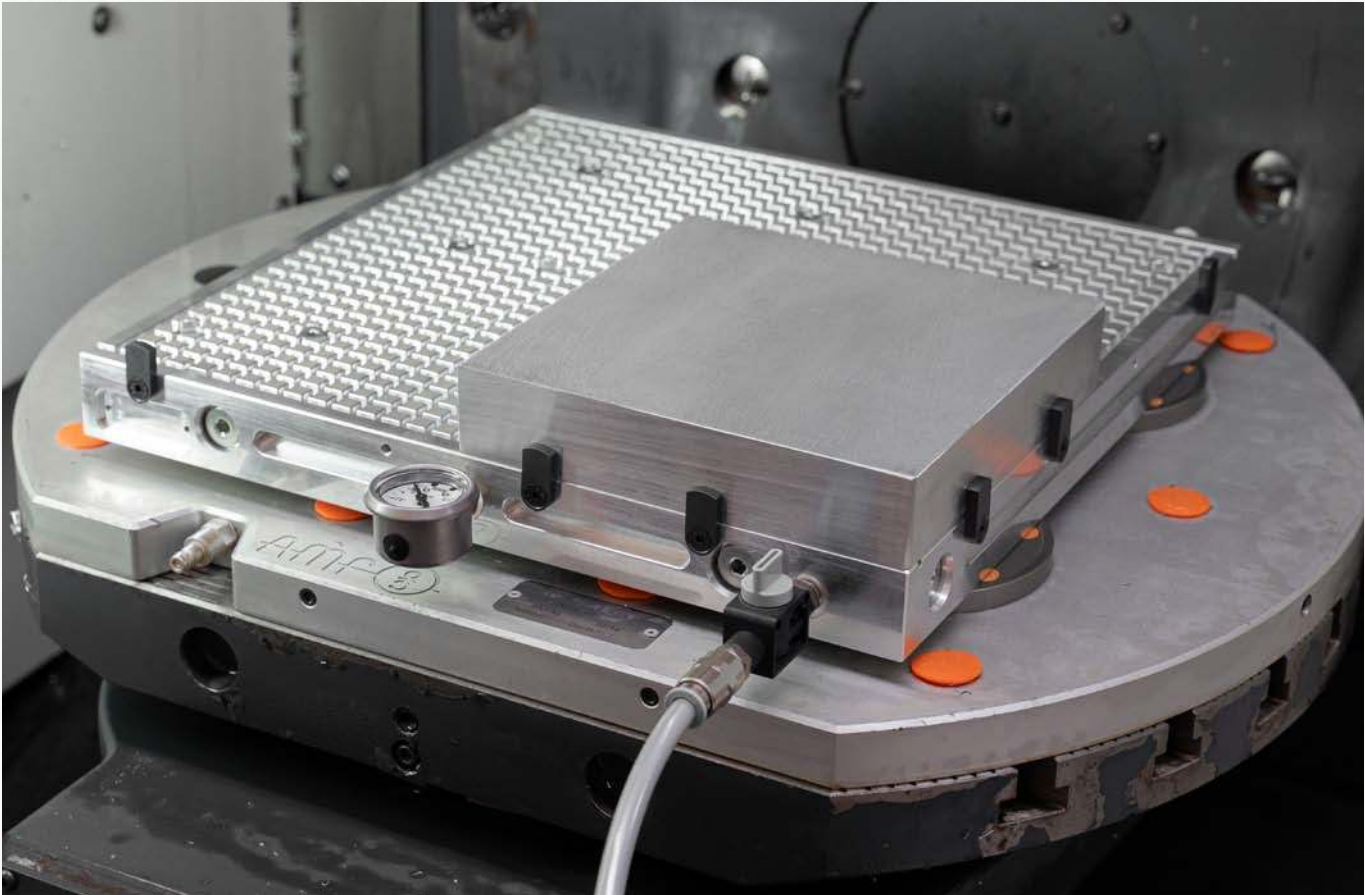

No. 7800VDS
Vacuum pressure sensor with accessories

Electrical connection:
 cable with plug according to EN 60947-5-2, round design M 8x1, 4-pole, cable length 0.3 m.
 supplied as standard consisting of:
 - pressure sensor
 - vacuum tubing outside diameter-Ø 4 mm, length 100 cm
 - plug connection D4 - G1/8-IG
 - double nipple G1/8-AG - G1/4-AG



Order no.	Indicators area [bar]	Ambient temp. [°C]	Operating pressure for max. vacuum [bar]	max. vacuum [%]	Max. suction volume flow [l/min.]	Weight [g]
563563	-1 ... 0	0-50	3,5	92	48,8	140

Application:

The threshold values (variable: 2 x relative pressure) are set on the pressure sensor using teaching and if the vacuum pressure drops, the machine is switched off. Is delivered ready for connection and can be connected directly to the vacuum clamping plate (G1/4).

Advantage:

The vacuum pressure sensor serves to monitor the applied air pressure. If the pressure drops, the machine is switched off. This contributes decisively to process reliability.

No. 7800E
Eccentric stop

Steel, burnished quenched.
 Complete with flat-head screw M5, packed in pairs.



Order no.	W x L [mm]	Weight [g]
563605	14 x 28	15

Advantage:

The sliding forces are absorbed by the stop.

No. 7800V
Vacuum meter

With sealing ring 7800VD.



Order no.	Indicators area [bar]	dia. [mm]	Connection below	Weight [g]
563550	-1 ... 0	48	G1/4	150

No. 7800VD
Sealing ring

for vacuum meter



Order no.	Connection	Weight [g]
563545	G1/4	0,6

Application:

Sealing ring is used in installation of the vacuum meter.

No. 7800VVB

Vacuum connector



Order no.	dia. [mm]	Length [mm]	Weight [g]
565332	22	19	12

Application:

When connecting several vacuum clamping plates of Premium Line 7800P and Premium Diamond 7800PD, we recommend sanding the plates flat on the bottom to compensate for height tolerances.

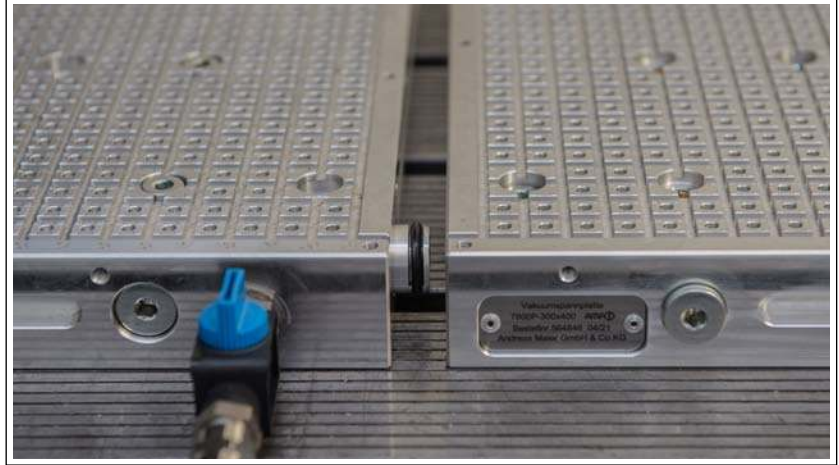

No. 7800VSD

Sound absorber

Housing and absorber insert of PE.



Order no.	Connection	Ambient temp. [°C]	Weight [g]
563543	G1/4	-10 - 60	8

Application:

Can be screwed directly into the vacuum clamping plate.

Note:

Check sound absorber regularly for fouling.

CAD



No. 7800AV

Ball-Valve

Manually operated. With O-ring seal.



Order no.	Connection	Hose dia., outer [mm]	Weight [g]
563541	G1/4	10	85

Application:

The stop valve is screwed directly into the plate on the vacuum clamping plates with an integrated Venturi nozzle.

CAD



Subject to technical alterations.

No. 7800VKS

Coupling connector for quick-release coupling

NW 7.2



Order no.	Hose dia., outer [mm]	L [mm]	Weight [g]
563560	10	57	47

Design:

Order no. 563560 2-part: coupling connector (brass) and coupling plug for hose outside Ø 10 mm.

Advantage:

Easy connection with the pneumatic hose of the vacuum clamping plate.

No. 908GX

Screw plug

with rubber seal



Order no.	Connection	Weight [g]
374553	G1/8	7
563546	G1/4	17

Application:

Can be screwed directly into the in vacuum clamping plate.

CAD



No. 7800VAF

Suction filter

Housing of brass, filter insert of tin bronze.



Order no.	Connection	Weight [g]
374884	G1/8	2

Application:

The suction filter is screwed into the vacuum clamping plate.

Note:

Check suction filter regularly for fouling.

CAD



No. 7800ZS

ISO 8734-4x12-A cylinder pin

Steel.



Order no.	Packaging unit [St]	Weight [g]
374603	10	15

Application:

Easy positioning of workpieces by fastening in the holes provided in the vacuum clamping plate.

Advantage:

The sliding forces are absorbed by the stop.

No. 7800S

Pneumatic hose



Order no.	Hose dia., outer [mm]	Length [m]	Weight [g]
563544	10	10	500

Note:

Ambient temperature -35 °C to +60 °C.

No. 6325

Clamps for machine vices

Tempered steel, milled, quenched in blue oxide finish. Packaged in pairs.



Order no.	H	B1	L	for clamping screw metric	for clamping screw inch	A	A1	A2	B2	E1	E2	Weight [g]
74682	15	16,5	78	M12, 14, 16	1/2, 5/8	22,5	10	6,5	40	10,5	40	660

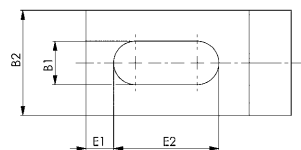
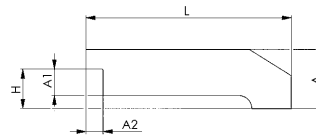

CAD



Subject to technical alterations.

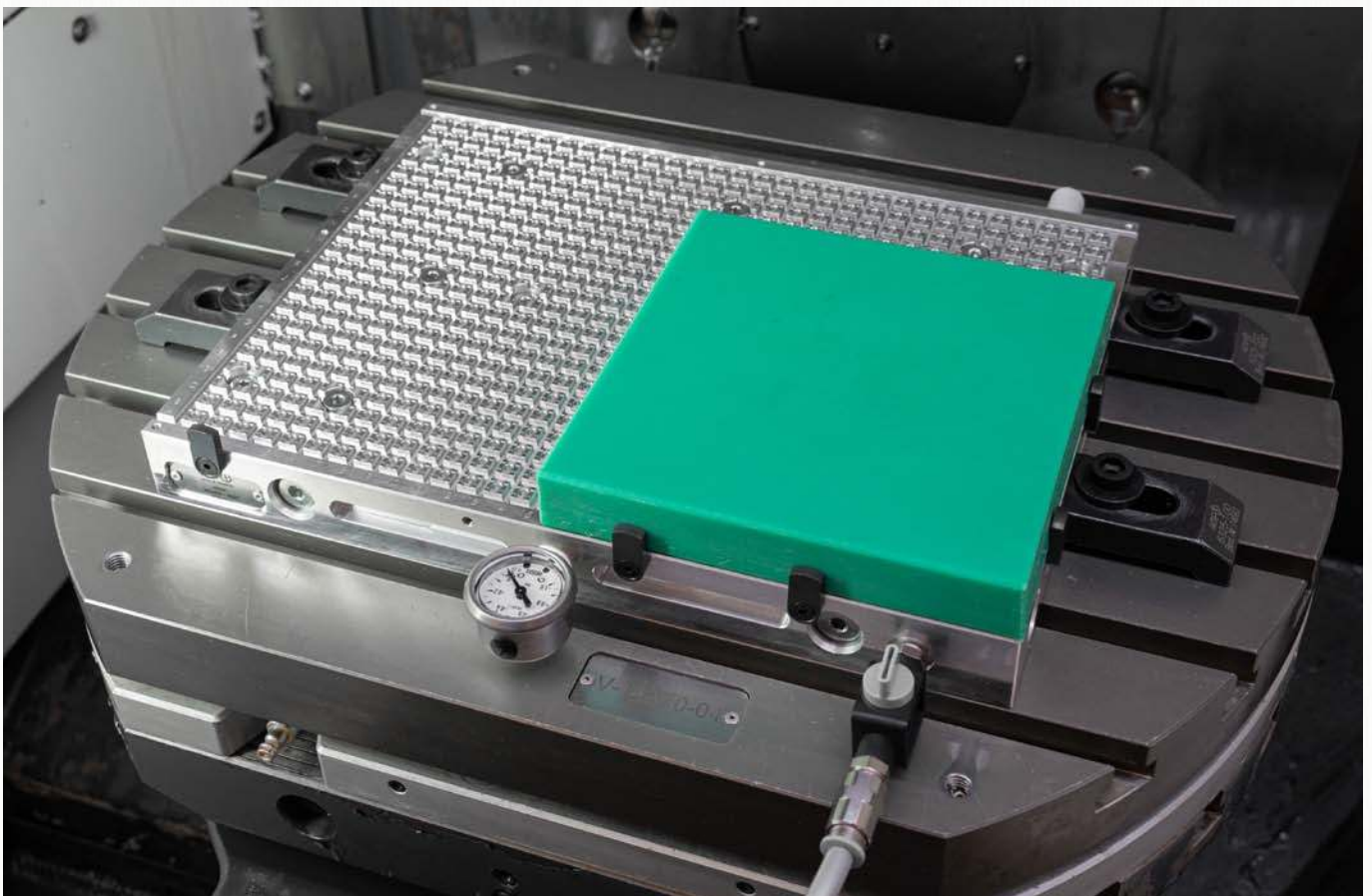

... BY ITEM NO.

Article no.	Page	Article no.	Page
No. 6325	20	No. 7800VDS	17
No. 7800AMG	10	No. 7800VKS	19
No. 7800APA	11	No. 7800VP	13
No. 7800AV	18	No. 7800VPF	13
No. 7800BV	9	No. 7800VSD	18
No. 7800D	15	No. 7800VVB	18
No. 7800E	17	No. 7800ZS	20
No. 7800P	7	No. 7810AB	12
No. 7800S	20	No. 7810AMG	12
No. 7800V	17	No. 7810APA	12
No. 7800VAF	19	No. 908GX	19
No. 7800VD	17	Nr. 7800PD	6
No. 7800VDR	14	Nr. 7800VPE-10-K	14

... BY ORDER NO.

Order no.	Page	Order no.	Page	Order no.	Page	Order no.	Page
374512	15	375048	10	563547	13	565332	18
374553	19	375097	11	563550	17	567156	14
374603	20	375485	10	563560	19	567157	14
374876	11	375626	12	563563	17	568936	6
374884	19	375642	12	563567	11	568939	6
374892	11	427930	12	563605	17	568940	6
374900	11	563167	15	563703	7	569353	9
374918	11	563541	18	564844	7	569354	9
374975	13	563543	18	564845	7	569355	9
375014	10	563544	20	564846	7	569356	9
375022	10	563545	17	564848	7	569485	10
375030	10	563546	19	564849	7	74682	20

... IN ALPHABETICAL ORDER

Description	Page
A	
Adapter mat, rubber	10, 12
Adapter plate, aluminium	11, 12
B	
Ball-Valve	18
C	
Clamps for machine vices	20
Coupling connector for quick-release coupling	19
E	
Eccentric stop	17
I	
ISO 8734-4x12-A cylinder pin	20
L	
Liquid separator	13
P	
Pneumatic hose	20
Pressure control valve	14
R	
Rotary vane vacuum pump	13
S	
Screw plug	19
Sealing cord	15
Sealing ring	17
Sound absorber	18
Suction filter	19
Surface-mounted block	12
V	
Vacuum clamping plate, Basic Line	9
Vacuum clamping plate, Premium Diamond, diamond coating to increase the friction coefficient	6
Vacuum clamping plate, Premium Line	7
Vacuum connector	18
Vacuum meter	17
Vacuum pressure sensor with accessories	17
Venturi nozzle connecting set	14

These Terms of Payment apply for companies, legal entities governed by public law and public law special funds. Our goods and services are supplied exclusively on the basis of the following conditions. Any deviating purchasing conditions of the customer not expressly recognised by us will not become part of the contract through acceptance of the order. By placing the order and accepting the goods we deliver, the customer confirms its consent to our terms and conditions.

1. Offer and contractual conclusion

All our offers are always subject to change without notice unless otherwise explicitly agreed. Our delivery contracts are based on the latest version of our catalogue. Dimension and weight values, as well as illustrations, drawings and data, are non-binding and can be changed by us at any time. Therefore, deviations cannot be ruled out and do not justify any compensation claims against us.

Orders are considered accepted only when confirmed by us in writing. If, for organisational reasons, the customer does not receive a separate confirmation upon the delivery of goods, the invoice shall also be deemed the order confirmation.

2. Prices

The prices are in EURO, ex-works, excluding VAT, packing, freight, postage and insurance. Unless otherwise agreed, our list prices valid on the day of delivery shall apply. For orders below 50 EUR goods net, we must make a minimum quantity surcharge of a 20 EURO for cost reasons.

3. Tool costs

Unless any other agreements have been reached, the tools fabricated for the purpose of executing the order shall remain our property in all cases, even if we have invoiced a tool cost component separately.

4. Payment

Unless otherwise stated on the invoice, the purchase price falls due for net payment within 30 days of the invoice date (without deduction of discount). Invoice amounts of below 50 EURO are due for payment immediately.

In case of payment default, we shall be entitled to charge default interest. The amount corresponds to our interest rate for current account credits at our main bank; the minimum however being 8 percentage points above the relevant base interest rate applied by the European Central Bank. Moreover, in case of default following written notice to the customer, we shall be entitled to cease to fulfil our obligations until payments are received.

5. No set-off

The customer can set-off only with legally confirmed or undisputed counterclaims.

6. Right of withdrawal in case of delayed acceptance or payment and insolvency

If the customer fails to accept the goods in due time, we shall be entitled to set a reasonable period of grace, after which we can dispose of the goods elsewhere and supply the customer on a reasonably longer term. Our rights to withdraw from the contract under the provisions of Section 326 BGB and demand damages for non-performance shall not be affected. If the customer fails to pay for the goods once payment is due, we shall be entitled, at the end of a reasonable period of grace we have set, to withdraw from the contract and demand the return of any goods already supplied. Section 323 BGB remains unaffected in all other cases.

If the customer applies for the opening of insolvency proceedings, we shall be entitled, prior to the ordering of security measures by the insolvency court, to withdraw from the contract and demand the immediate return of the goods.

7. Customer-specific fabrications/project fabrications (custom fabrications)

Customer-specific fabrications require binding information on design, quantity etc. in written form at the time of ordering. For manufacturing reasons, we reserve the right to supply up to 10% above or below the order quantity. Technical modifications or cancellations are subject to any costs incurred. The return of customer-specific fabrications is impossible.

8. Delivery and packaging, transfer of risk

The delivery date is non-binding; although stated to the best of our knowledge. It is subject to us receiving correct, defect-free and complete deliveries. The stated delivery dates relate to completion in the factory, starting on the day the order is accepted by us. Delivery is EXW (ex-works) in accordance with Incoterms 2010. Therefore, the costs are borne by the customer. The risk is transferred to the customer when the goods are passed to the person, company or facility nominated to execute the shipment. This applies also for partial deliveries, or if we have assumed responsibility for delivery and installation. The risk shall be transferred to the customer even in the case of delayed acceptance.

In the absence of specific shipping instructions, we shall proceed as we deem fit and without any obligation to the cheapest or most expedient method. The customer agrees that the order can also be delivered in parts, insofar as this is reasonable for the customer. We shall charge a 5 EURO processing free for shipping to third parties that we supply on behalf of the customer.

The packaging complies with the packaging ordinance. Disposable packaging shall be charged at cost price. The packaging cannot be taken back.

9. Performance impediment and/or impossibility

If we are hindered in the fulfilment of our obligation due to the onset of unforeseeable circumstances, which we are unable to avoid despite reasonable effort in relation to the nature of the circumstances (e.g. operational interruption, delay in the delivery of important raw materials, defects in the delivery), the delivery time shall be extended by a reasonable period, insofar as the supply of goods or services is not rendered unreasonably difficult or impossible.

If we have to accept that these circumstances are not only temporary, we shall be entitled to withdraw from the contract either in whole or in part.

If the supply of goods or services becomes impossible, the customer shall not be obliged to furnish its own contractual service. Section 275 BGB applies mutatis mutandis. If, however, the customer is solely or predominantly responsible for the

circumstances that led to impossibility, it shall remain under an obligation to render the return service. The same applies if this circumstance occurs at a time when the customer is behind schedule with acceptance.

10. Samples/returns

Samples shall be provided only against payment. If samples or models are provided, a credit note shall be issued with the subsequent order if the order value is 125 EURO net or more. Goods can be returned only by agreement, although custom fabrications are excluded from such return.

In the case of returns for which we are not responsible (e.g. incorrect order), we shall charge a processing fee of 10%, the minimum value, however, being 7.50 EURO.

11. Retention of title

The goods shall remain our property unless full payment of all claims and/or until the cheques provided for this purpose are honoured. The itemisation of claims in an ongoing invoice, as well as balancing the account and the recognition thereof does not affect the retention of title. The customer is entitled to sell on the retained goods during the ordinary course of business. However, the customer is not permitted to pledge the goods or transfer them by way of security. It shall assign its claim ensuing from the selling on of the retained goods to us in advance. The customer shall be entitled to collect the claim to the extent that it has fulfilled its obligations towards us. At our request, the customer shall be obliged to state third-party debtors and we shall be entitled to report this and the assignment.

12. Property rights

We reserve property rights and copyrights to all contractual documents such as drafts, drawings, calculations and cost estimates. Such documents must not be reproduced or disclosed to third parties without our consent. Any rights to patents, utility models etc. reside solely with us, insofar as such patents have not yet been filed. Our products are allowed to be replicated only with our written consent.

If objects are fabricated according to drawings or samples, the customer shall warrant that any third party property rights are not infringed by manufacture or delivery. If a third party forbids manufacture and delivery on account of property rights, we shall be entitled to stop manufacture and delivery immediately. The customer shall be obliged to reimburse us with all costs incurred and indemnify us from third party compensation claims. Compensation claims by the customer are impossible.

13. Warranty

If the customer agrees with us a particular quality of the goods, we shall base this agreement on our technical delivery specifications. If we have to deliver according to customer drawings, specifications, samples etc., the customer shall assume the risk for suitability for the intended purpose. If, after the contract is concluded, the scope of goods or services is changed at the customer's request and this impairs the quality or suitability of the goods, claims for defects on the part of the customer shall be ruled out, insofar as such impairments are caused by the customer's requests for change. The time at which the risk is transferred is decisive for the contractual state of the goods. Wear and tear of wearing parts caused by ordinary use does not constitute a defect. Claims for defects are ruled out in the following cases in particular: Unsuitable or improper use, incorrect installation and/or commissioning by the customer or third party, normal wear and tear, incorrect or negligent handling - in particular excessive use -, unsuitable equipment, replacement materials, chemical, electrochemical or electrical influences, unless such defects are caused by ourselves.

If the goods contain a defects, we shall provide, following a reasonable period of grace set by the customer, either a replacement or a repair as we deem fit. If such subsequent performance fails, the customer shall be entitled to either reduce the purchase price or withdraw from the contract. Any further warranty claims are ruled out. In case of negligible deviations from the agreed quality, no claims for defects shall be recognised.

The discovery of defects must be communicated to us immediately in writing. In the case of recognisable defects, however, within 10 days of acceptance, in the case of non-recognisable defects immediately after they become evident. The warranty is 12 months, starting with delivery of the goods ex-works.

14. Liability

With the exception of harm to life, body or health on account of a breach of duty by ourselves, our liability shall be limited to intent or gross negligence.

15. Place of fulfilment, place of jurisdiction and governing law

The place of fulfilment for all obligations ensuing from this contractual relationship is D-70734 Fellbach.

The place of jurisdiction for all legal disputes ensuing from the contractual relationship is the court responsible for the headquarters of Andreas Maier GmbH & Co. KG.

All disputes ensuing from the contract or regarding the validity thereof shall be finally decided by a court of arbitration in accordance with the Court of Arbitration Ordinance of the German Committee for Arbitration Court Procedures or the Conciliation and Arbitration Arrangement of the International Chamber of Commerce, recourse to ordinary courts of law being excluded. The legal dunning process, however, remains permissible.

German law shall govern (BGB and HGB). The applicability of the UN Convention on Contracts for the International Sale of Goods (CISG) is ruled out.

16. Severability clause

If individual provisions become legally invalid, the remaining provisions shall not be affected. The legally invalid provision shall be replaced by regulations that most closely reflect the economic purpose of the contract with reasonable consideration for the mutual interests. The publication of these Terms of Sale, Delivery and Payment renders all previous versions invalid. This does not apply for any contracts concluded prior to announcement.

VACUUM CLAMPING SYSTEMS CATALOGUE 2023/2024

Request additional catalogues from www.amf.de



ZERO-POINT-SYSTEMS



HYDRAULIC CLAMPING SYSTEMS



VACUUM CLAMPING SYSTEMS

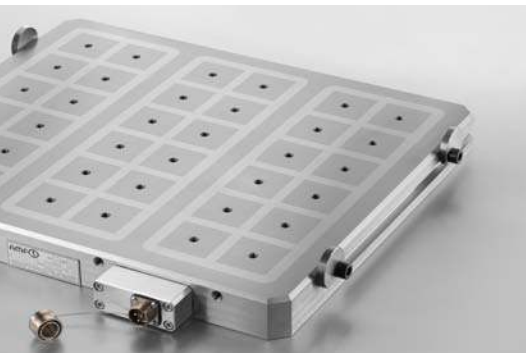

MAGNETIC CLAMPING SYSTEMS



WIRELESS SENSING SYSTEMS



TOGGLE CLAMPS



SINGLE AND MULTIPLE CLAMPING SYSTEMS



STANDARD CLAMPING SYSTEMS



MARKING AND CLEANING TOOLS



ANDREAS MAIER GmbH & Co. KG

Waiblinger Straße 116 · D-70734 Fellbach

Phone: +49 711 5766-0

Fax: +49 711 575725

E-mail: amf@amf.de

Web: www.amf.de

Order no. 547414 · € 2,40