

82500

Wall brochure holder for DIN A4 (portrait)

DURABLE
Design

- Brochure holder made of impact-resistant polystyrene
- Set consisting of 12 brochure racks with compartments for DIN A4 format
- Fill depth per compartment approx. 24 mm
- Delivery incl. installation material

Applications

Organisation and presentation of information, documents, order pockets, catalogue and advertising material etc.



82500 101

82500 102



Figure shows 2 sets

Colour	82500	...
Transparent		101
Black		102

82465

RasterPlan perforated plate system

KAPPES
Design

- Systematic method to achieve tidiness with RasterPlan perforated plates
- Clearly arranged tool storage
- Fast access
- Systematic and colour-based organisation
- Impact-resistant and scratch-resistant plastic coating
- Specially shaped beams
- Sheet steel 1.25 mm
- Concealed screw holes
- 6 brilliant colours
- 4 sizes, 8 flexible applications
- Compatible with RasterPlan slotted plates
- Delivery without tool holder

Applications

Can be combined and applied universally, from a single perforated plate on a wall, dividers, trolleys and partitions to workshop cabinets and pull-out cabinets.

Note:

For tool holders, see art. no. 82471-82483.

82465

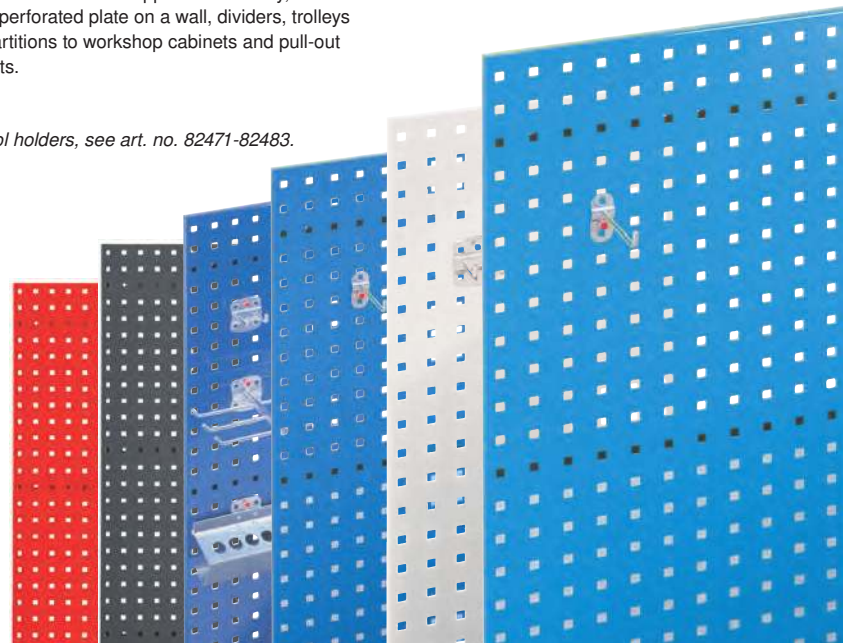
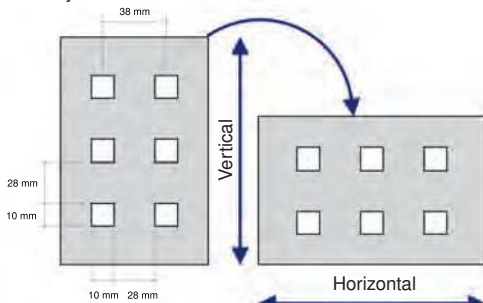

Dimensions W x H mm	500 x 450	...	1000 x 450	...	1500 x 450	...	2000 x 450	...
Plate colour	82465	...	82465	...	82465	...	82465	...
RAL 5012 light blue		310		401		501		701
RAL 7035 light grey		306		406		506		706
RAL 5015 sky blue		311		402		502		702
RAL 5010 gentian blue		312		403		503		703
RAL 7016 anthracite grey		316 NEW		416 NEW		516 NEW		716 NEW
RAL 3020 traffic red		304 NEW		404 NEW		504 NEW		704 NEW

82471

Tool holder assortments for perforated plates

KAPPES
Design

The right hook for any tool, plastic-coated, aluminium-coloured. The hooks are simply inserted into the required hole and fixed in place with a small plastic screw.

Tool holder assortments	82471	...
10 pieces		100
12 pieces		101
15 pieces		102
18 pieces		103
28 pieces		104
40 pieces		105

82471 100



82471 101



82471 102

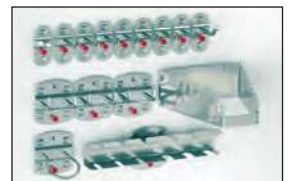

82471 103



82471 104



82471 105



Factory equipment

Tool holders

82480

Tool holders for perforated plates

KAPPES

Design

- Tool holders create order and clarity.
- Impact-resistant and scratch-resistant plastic coating, aluminium-coloured
- Embossed base plate 1.5 mm thick
- Including RasterPlan plastic screw



82480 101-104

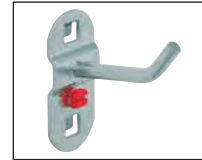

82480 105-107

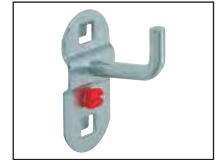

82480 108-111



82480 112-116



82480 117-121

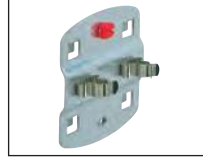

82480 122-124



82480 125-127



82480 128



82480 129

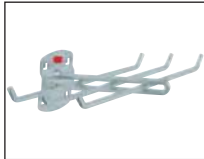

82480 130



82480 131



82480 132-133



82480 134-135



82480 136



82480 137



82480 138

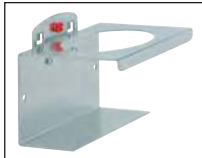

82480 173

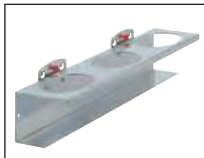

82480 139



82480 140-141

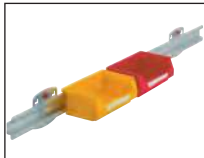

82480 142



82480 143



82480 144

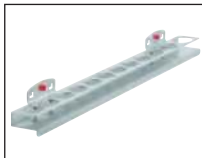

82480 150

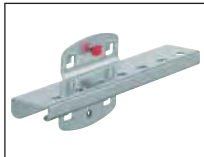

82480 151

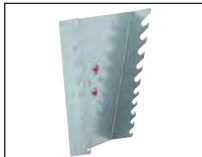

	Size mm	Ø mm	Pack= pieces	82480	...
Tool holder with angled hook end	50	6	5		101
Tool holder with angled hook end	100	6	5		102
Tool holder with angled hook end	150	6	5		103
Tool holder with angled hook end	200	6	5		104
Tool holder with vertical hook end	35	6	5		105
Tool holder with vertical hook end	75	6	5		106
Tool holder with vertical hook end	125	6	5		107
Tool holder, double	35 x 35	6	5		108
Tool holder, double	50 x 35	6	5		109
Tool holder, double	75 x 35	6	5		110
Tool holder, double	150 x 35	6	5		111
Tool clamp, single	-	6	5		112
Tool clamp, single	-	10	5		113
Tool clamp, single	-	13	5		114
Tool clamp, single	-	16	5		115
Tool clamp, single	-	19	5		116
Tool clamp, double	-	6	5		117
Tool clamp, double	-	10	5		118
Tool clamp, double	-	13	5		119
Tool clamp, double	-	16	5		120
Tool clamp, double	-	19	5		121
Pliers holder	35 x 20	-	5		122
Pliers holder	55 x 20	-	5		123
Pliers holder	75 x 20	-	5		124
Machine holder	-	40	1		125
Machine holder	-	60	1		126
Machine holder	-	80	1		127
Tool holder 3x	150 x 45	-	1		128
Tool holder 6x	140 x 240	-	1		129
Combination holder, 2 pieces	150 x 55	-	1		130
Wrench holder, horizontal	For 8 wrenches	-	1		131
Screwdriver holder	For 6 parts	-	1		132
Screwdriver holder	For 12 parts	-	1		133
Drill holder	For 14 parts	-	1		134
Drill holder	For 28 parts	-	1		135
Saw holder	For 4 saws	-	2		136
Shelf	350 x 125	-	1		137
Round can holder 1x	100	70	1		138
Round can holder 3x	300	70	1		173
Hose holder	230 x 125	-	1		139
Easy-view storage bin holder 5x for size 7	550 x 58	-	1		140
Easy-view storage bin holder 5x for size 8	550 x 38	-	1		141
Tool holder for self-drilling	120 x 45	-	1		142
Tool holder for self-drilling	390 x 45	-	1		143
Socket holder tray 12 holes	390 x 30	-	1		144
Bit holder 7 pieces	150 x 35	-	1		150
Box wrench holder, vertical	For 10 wrenches	-	1		151
Wrench holder, vertical	For 10 wrenches	-	1		152
Brochure holder DIN A4, RAL 7035 light grey	220 x 310	-	1		160
Brochure holder DIN A3, RAL 7035 light grey	440 x 310	-	1		174

Factory equipment



	Size mm	Ø mm	Pack= pieces	82480	...
Form holder DIN A4, RAL 7035 light grey	220 x 310	-	1		165
Spare screws	-	-	100		166
Paper dispenser for width 295 mm	355 x 120	-	1		171
Tool holder with straight pin, single	50	6	5		175
Tool holder with straight pin, single	100	6	5		176
Tool holder with straight pin, single	150	6	5		177
Tool holder with straight pin, double	50	6	5		178
Tool holder with straight pin, double	100	6	5		179
Tool holder with straight pin, double	150	6	5		180
Magnetic holder	-	40	1		181
Angled hook for socket-wrench and screwdriver bits	14/40	6	1		182
Base plate for building your own	Small	-	1		183
Base plate for building your own	Large	-	1		184
Round holder	65 x 25	-	1		185
Pipe holder	35	60	1		186
Pipe holder	35	100	1		187
Tool holder, self-service	125 x 30	-	1		188
Cable holder	150 x 37	6	1		189
Cable holder	200 x 37	6	1		190
Hexagon socket holder	For 9 wrenches	1 - 11	1		191
Tool holder for MK2	85 x 395	17	1		192
Tool holder for MK3	85 x 395	23	1		193
Easy-view storage bin holder 1x	For sizes 7 + 8	-	1		194
Clamping piece holder	55	From 19	1		195
Coil holder axle 17 mm	Max. 78	170	1		196
Holder for oval cans	50 x 500	-	1		197
Tool holder box with wooden panel	320 x 135 x 55	-	1		198
Storage box	55 x 320 x 135	-	1		199
Dispenser holder for width 300 mm, core Ø min. 22 mm, RAL 7035 light grey	310 x 384	220	1		200
Bin-liner holder, 2 pieces, aluminium-coloured, size bottom H 305 x W 300 x D 120 mm	top H 350 x W 305 x D 130	-	1		201
Sandpaper dispenser holder, aluminium-coloured (2 rolls W 120 mm - max. 4 rolls W 55 mm)	H 265 x W 342 x D 290	-	1		172
Steel shelf with anti-roll-off edging, RAL 7035 light grey	490 x 243	-	1		202
Steel shelf storage, RAL 7035 light grey	435 x 250	-	1		203

KAPPES

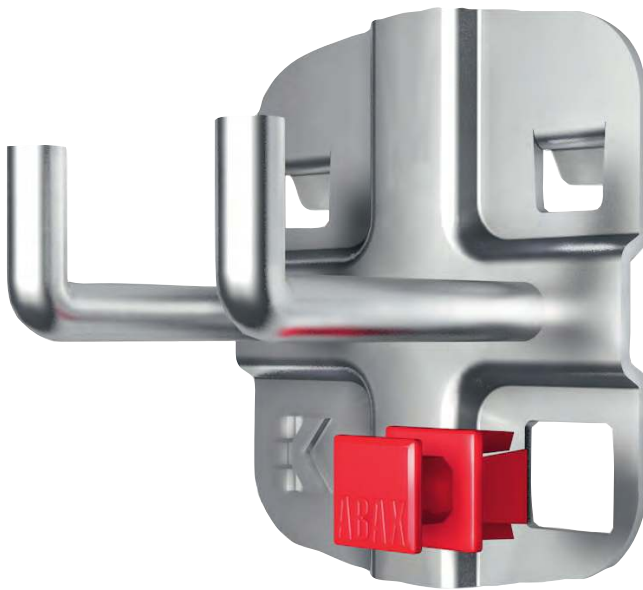

ABAX® connects RasterPlan tool holders to all Kappes products with RasterPlan system perforation in seconds and without the need for tools.

Design

RasterPlan tool holders with ABAX®connection are an innovative and fully compatible extension of the well-known RasterPlan tool holder.

ABAX® connects RasterPlan tool holders to all Kappes products with RasterPlan system perforation in seconds and without the need for tools.

Positive locking and securing is performed after mounting by fixing the ABAX® connection and pressing on the locking pin.

By simply pulling out the locking pin without the use of tools, the ABAX® connection can be released and re-used. ABAX® enables fast and flexible positioning of RasterPlan tool holders. RasterPlan and ABAX® – a strong connection!

Advantages:

- Tool-free installation
- Simple and safe handling
- Maximum flexibility as dismantled without tools
- Impact-resistant and scratch-resistant plastic coating
- Embossed base plates 1.5 mm thick
- 2 organisational colours, aluminium-coloured or anthracite grey (deliverable on request)
- Including original ABAX® connection

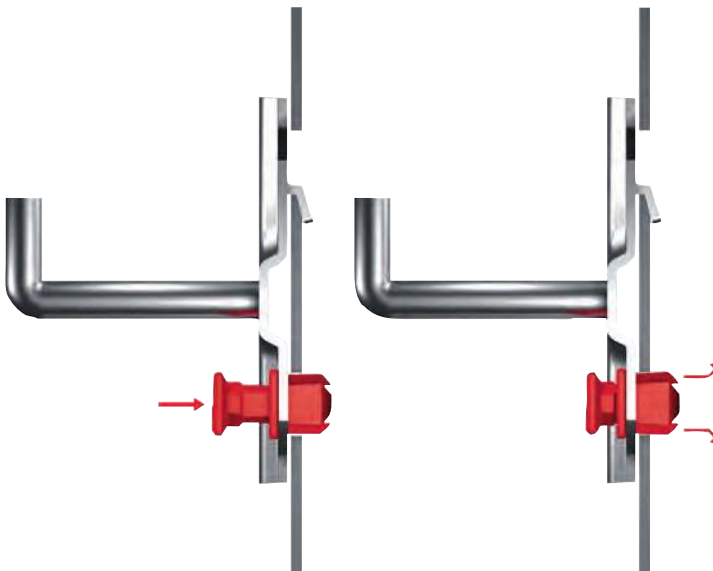
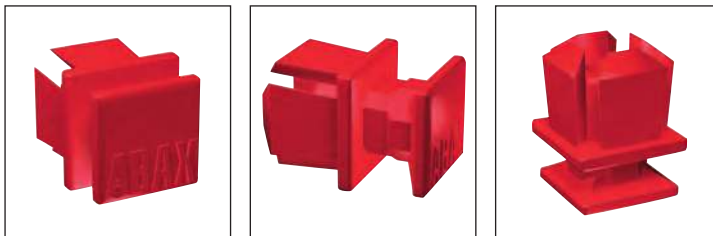

Factory equipment

KAPPES

Tool holder with angled hook end

Length mm	Ø mm	Anthracite		Aluminium-coloured	
		82481	...	82481	...
50	6	301	...	101	...
100	6	302	...	102	...
150	6	303	...	103	...
200	6	304	...	104	...



Tool holder with vertical hook end

Length mm	Ø mm	Anthracite		Aluminium-coloured	
		82481	...	82481	...
35	6	305	...	105	...
75	6	306	...	106	...
125	6	307	...	107	...

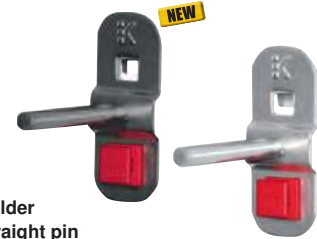

Tool holder with straight pin single

Length mm	Ø mm	Anthracite		Aluminium-coloured	
		82481	...	82481	...
50	6	308	...	108	...
100	6	309	...	109	...
150	6	310	...	110	...



Double tool holder with angled hook end

Length mm	Ø mm	Anthracite		Aluminium-coloured	
		82481	...	82481	...
50	6	312	...	112	...
75	6	313	...	113	...
150	6	314	...	114	...



Double tool holder with vertical hook end

Length mm	Ø mm	Anthracite		Aluminium-coloured	
		82481	...	82481	...
35	6	315	...	115	...
50	6	316	...	116	...
75	6	317	...	117	...
150	6	318	...	118	...



Double tool holder with straight pin

Length mm	Ø mm	Anthracite		Aluminium-coloured	
		82481	...	82481	...
50	6	319	...	119	...
100	6	320	...	120	...
150	6	321	...	121	...



Machine holder

Inner Ø mm	Anthracite		Aluminium-coloured	
	82481	...	82481	...
40	323	...	123	...
60	324	...	124	...
80	325	...	125	...



Round holder

Length mm	Width mm	Anthracite		Aluminium-coloured	
		82481	...	82481	...
65	25	326	...	126	...



Pliers holder

Width mm	Depth mm	Anthracite		Aluminium-coloured	
		82481	...	82481	...
35	20	335	...	135	...
40	50	336	...	136	...
50	75	337	...	137	...
55	20	338	...	138	...
75	20	339	...	139	...



Angled hook for sockets and socket wrenches

Length mm	Ø mm	Anthracite		Aluminium-coloured	
		82481	...	82481	...
14/40	6	342	...	142	...



Base plate for individual solutions

	Anthracite		Aluminium-coloured	
	82481	...	82481	...
Small	385	...	185	...
Large	386	...	186	...



Magnetic holder

Ø mm	Anthracite		Aluminium-coloured	
	82481	...	82481	...
40	322	...	122	...

Continued ▶

Tool holders

82481

Tool holder for perforated plates RasterPlan powered by ABAX®

KAPPES

NEW



Tool clamp, single, small base plate

Ø mm	Anthracite		Aluminium-coloured	
	82481	...	82481	...
6			380	180
10			381	181
13			382	182
16			383	183
19			384	184

NEW



Double tool clamp

Ø mm	Anthracite		Aluminium-coloured	
	82481	...	82481	...
6			327	127
10			328	128
13			329	129
16			330	130
19			331	131

NEW



Tool clamp, single, large base plate

Ø mm	Anthracite		Aluminium-coloured	
	82481	...	82481	...
25			332	132
28			333	133
32			334	134



NEW



Saw holder (please order in pairs)

	Anthracite		Aluminium-coloured	
	82481	...	82481	...
For 4 saws			351	151

NEW



Pipe holder also for hoses, cables etc.

Width mm	Ø mm	Anthracite		Aluminium-coloured	
		82481	...	82481	...
70	62			349	149
70	100			350	150



NEW



Tool holder for self-service packaging

Length mm	Width mm	Anthracite		Aluminium-coloured	
		82481	...	82481	...
125	30			347	147



NEW



Cable holder

Length mm	Width mm	Hook end height mm	Anthracite		Aluminium-coloured	
			82481	...	82481	...
100	37	50			348	148
150	37	50			345	145
200	37	50			346	146



NEW



Tool holder, 3x

Length mm	Width mm	Anthracite		Aluminium-coloured	
		82481	...	82481	...
150	45			344	144



NEW



Tool holder, 6x

Length mm	Width mm	Anthracite		Aluminium-coloured	
		82481	...	82481	...
140	240			343	143



NEW



Drill/hexagon socket holder (var. Ø)

	Height mm	Width mm	Depth mm	Anthracite		Aluminium-coloured	
				82481	...	82481	...
For 14 parts	35	200	30			371	171
For 28 parts	35	390	30			374	174

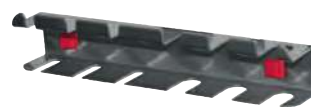

NEW



Screwdriver holder

	Height mm	Width mm	Depth mm	Anthracite		Aluminium-coloured	
				82481	...	82481	...
For 6 parts	40	200	30			369	169
For 12 parts	40	390	30			370	170

Continued ▶

Factory equipment

82481

Tool holder for perforated plates RasterPlan powered by ABAX®

KAPPES

Tool holder for self-drilling		Anthracite		Aluminium-coloured	
Holder mm	Length mm	82481	...	82481	...
390 x 58	390			388	188



Tool holder for self-drilling		Anthracite		Aluminium-coloured	
Holder mm	Length mm	82481	...	82481	...
110 x 58	110			387	187



Hexagon socket holder Ø 2-11 mm				Anthracite		Aluminium-coloured	
Height mm	Width mm	Depth mm		82481	...	82481	...
For 9 wrenches	50/70	200	25			368	168



Tool holder for MK-2 and MK-3				Anthracite		Aluminium-coloured	
Height mm	Width mm	Depth mm		82481	...	82481	...
MK-2 (15x Ø 17 mm)	85	395	60			340	140
MK-3 (12x Ø 23 mm)	85	395	60			341	141



Wrench holder, vertical				Anthracite		Aluminium-coloured	
Height mm	Width mm	Depth mm		82481	...	82481	...
For 10 wrenches	220	145/75	50			364	164



Box wrench holder, vertical				Anthracite		Aluminium-coloured	
Height mm	Width mm	Depth mm		82481	...	82481	...
For 10 wrenches	255	225/125	50			365	165

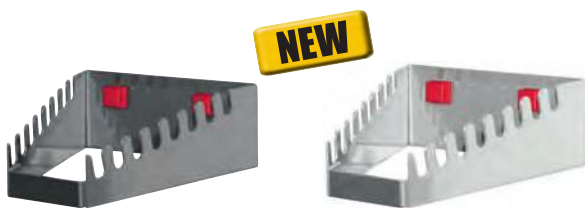

Wrench holder, horizontal				Anthracite		Aluminium-coloured	
Height mm	Width mm	Depth mm		82481	...	82481	...
For 8 wrenches	50	130/60	150			363	163



Coil holder			Anthracite		Aluminium-coloured	
For axle dimensions to mm	Width max. mm	Ø mm	82481	...	82481	...
17	78	170			357	157

Continued ▶

Tool holders

82481 Tool holder for perforated plates RasterPlan powered by ABAX®

KAPPES



Pipe holder, 3x			Anthracite	Aluminium-coloured
Height mm	Width mm	Depth mm	82481	82481
400	150	85	379	179

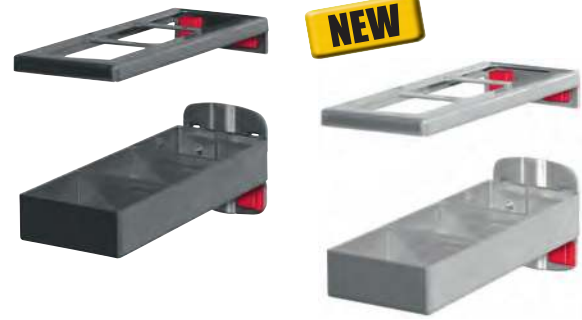

Combination holder, 2 piece		Anthracite	Aluminium-coloured
Length mm	Width mm	82481	82481
150	55	354	154



Easy-view storage bin holder 1x for box size 7 and 8		Anthracite	Aluminium-coloured
		82481	82481
For 1 bin		352	152

Delivery without easy-view storage bin



Easy-view storage bin holder for bin size 7 and		Anthracite	Aluminium-coloured
Length mm	Height mm	82481	82481
For 5 bins	525 38	353	153



Bit holder			Anthracite	Aluminium-coloured
Height mm	Width mm	Depth mm	82481	82481
For 7 bits	10 150	35	366	166



Shelf		Anthracite	Aluminium-coloured
Width mm	Depth mm	82481	82481
350	125	361	161
445	150	362	162



Tool holder box with wooden panel for self-drilling				Anthracite	Aluminium-coloured
Shelf mm	Height mm	Width mm	Depth mm	82481	82481
340 x 135 x 55	55	340	135	389	189



Storage box, large			Anthracite	Aluminium-coloured
Height mm	Width mm	Depth mm	82481	82481
55	340	135	359	159



Storage box, small			Anthracite	Aluminium-coloured
Height mm	Width mm	Depth mm	82481	82481
35	250	80	375	175



Socket holder			Anthracite	Aluminium-coloured
Height mm	Width mm	Depth mm	82481	82481
For 12 socket	30 390	45	367	167

Continued ▶

Factory equipment

82481

Tool holder for perforated plates RasterPlan powered by ABAX®

KAPPES**NEW**

Steel shelf/storage		Anthracite		Aluminium-coloured	
Width mm	Depth mm	82481	...	82481	...
435	250			358	458

**NEW**

Steel shelf with anti-roll-off edging		Anthracite		Aluminium-coloured	
Width mm	Depth mm	82481	...	82481	...
490	243			360	460

**NEW**

Spray-bottle holder, 1x		Anthracite		Aluminium-coloured	
Width mm	Ø mm	82481	...	82481	...
76	52			376	176

**NEW**

Pen holder		Anthracite		Aluminium-coloured	
Width mm	Ø mm	82481	...	82481	...
For 4 pens	112	17		377	177

**NEW**

Can holder, 1x		Anthracite		Aluminium-coloured	
Width mm	Ø mm	82481	...	82481	...
100	70			355	155

**NEW**

Round can holder, 3x		Anthracite		Aluminium-coloured	
Width mm	Ø mm	82481	...	82481	...
300	70			356	156

**NEW**

Combi holder for pens/spray bottle			Anthracite		Aluminium-coloured	
Width mm	4x Ø mm	1x Ø mm	82481	...	82481	...
176	17	52			378	178

**NEW**

Hose holder		Anthracite		Aluminium-coloured	
Width mm	Depth mm	82481	...	82481	...
230	125			372	172

**NEW**

Bin-liner holder, 2 pieces				Aluminium-coloured	
Ø top mm	Height top/bottom mm	Width top/bottom mm	Depth top/bottom mm	82481	...
250	350/305	305/300	130/120		192

Continued

Tool holders

82481

Tool holder for perforated plates RasterPlan powered by ABAX®

KAPPES

NEW



Sandpaper dispenser holder			Anthracite	Aluminium-coloured			
Max. number of rolls	Height mm	Width mm	Depth mm	82481	...	82481	...
For width up to 120/55 mm	mm	mm	mm				
2/4	170	370	320			373	173



NEW



Dispenser holder			Anthracite	Aluminium-coloured				
Core Ø min. mm	Roll width max. mm	Height mm	Width mm	Depth mm	82481	...	82481	...
22	295	120	355	100			390	190



NEW



Square perforation compatible with ABAX® tool holder

Pen box			Anthracite	Aluminium-coloured		
Height mm	Width mm	Depth mm	82481	...	82481	...
110	63	70			393	193



NEW



Brochure holder DIN A5		Anthracite	Aluminium-coloured		
Height mm	Width mm	82481	...	82481	...
230	150			391	491



NEW



NEW



Brochure holder DIN A4		Anthracite	Aluminium-coloured		
Height mm	Width mm	82481	...	82481	...
330	220			397	497

Brochure holder DIN A3		Anthracite	Aluminium-coloured		
Height mm	Width mm	82481	...	82481	...
330	440			396	496



NEW



File holder			Anthracite	Aluminium-coloured		
Height mm	Width mm	Depth mm	82481	...	82481	...
310	85	220			394	194



NEW



Document tray			Anthracite	Aluminium-coloured		
Height mm	Width mm	Depth mm	82481	...	82481	...
85	225	310			395	195

Factory equipment

82483

Tool holder assortments for perforated plates RasterPlan powered by ABAX®

KAPPES**Assortment, 10 pieces**

- 7 Tool holder with angled end
- 2 Double tool holder
- 1 Tool clamp

NEW

Anthracite Aluminium-coloured

Assortment contents	82483	...	82483	...
10 pieces		301	101	

**Assortment, 12 pieces**

- 4 Tool holder with vertical end
- 3 Double tool holder
- 1 Pliers holder
- 1 Machine holder
- 3 Tool holder with angled end

NEW

Anthracite Aluminium-coloured

Assortment contents	82483	...	82483	...
12 pieces		302	102	

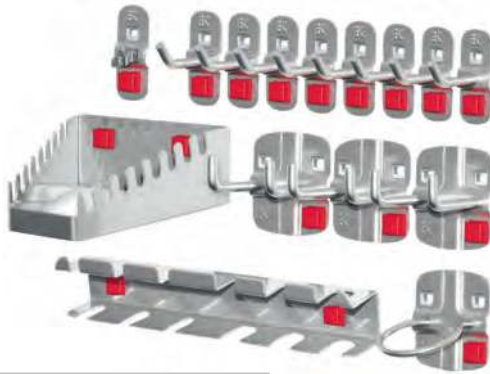
**Assortment, 15 pieces**

- 8 Tool holder with angled end
- 1 Screwdriver holder
- 3 Double tool holder
- 1 Wrench holder
- 1 Tool clamp
- 1 Machine holder

NEW

Anthracite Aluminium-coloured

Assortment contents	82483	...	82483	...
15 pieces		303	103	

**Assortment, 17 pieces**

- 8 Tool holder with angled end
- 4 Double tool holder
- 5 Tool clamps

NEW

Anthracite Aluminium-coloured

Assortment contents	82483	...	82483	...
17 pieces		307	107	

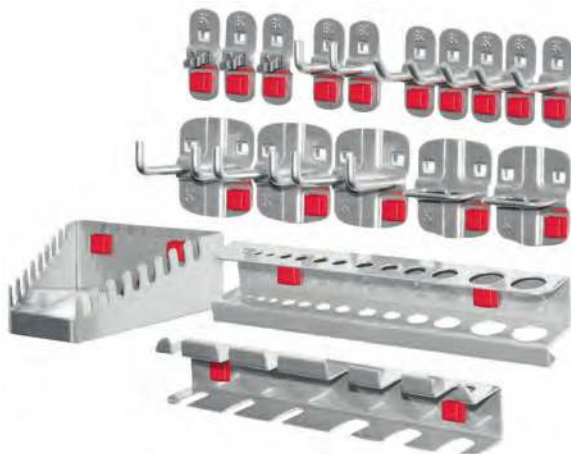
**Assortment, 18 pieces**

- 5 Tool holder with angled end
- 2 Pliers holder
- 2 Tool holder with vertical end
- 1 Drill holder
- 3 Double tool holder
- 1 Wrench holder
- 3 Tool clamps
- 1 Screwdriver holder

NEW

Anthracite Aluminium-coloured

Assortment contents	82483	...	82483	...
18 pieces		304	104	

**Assortment, 20 pieces**

- 5 Tool holder with vertical end
- 1 Bit holder
- 5 Double tool holder
- 1 Drill holder
- 5 Tool clamps
- 1 Wrench holder, vertical
- 2 Saw holder

NEW

Anthracite Aluminium-coloured

Assortment contents	82483	...	82483	...
20 pieces		308	108	

82483

Tool holder assortments for perforated plates RasterPlan powered by ABAX®

KAPPES



Assortment, 21 pieces

- 4 Tool holder with vertical end
- 1 Tool holder, 6x
- 4 Double tool holder
- 2 Pipe holder
- 3 Tool clamps
- 1 Wrench holder
- 3 Double tool clamps
- 1 Storage box, small
- 2 Machine holder

NEW

	Anthracite	Aluminium-coloured
Assortment contents	82483	82483
21 pieces	309	109



Assortment, 25 pieces

- 5 Tool holder with angled end
- 10 Tool holder with vertical end
- 5 Double tool holder
- 5 Tool clamps

NEW

	Anthracite	Aluminium-coloured
Assortment contents	82483	82483
25 pieces	310	110

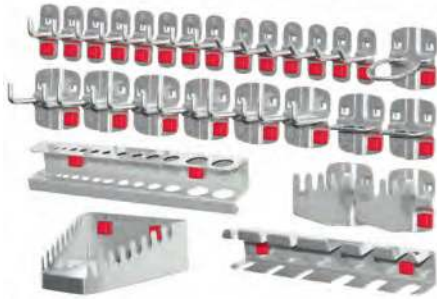

Assortment, 28 pieces

- 6 Tool holder with angled end
- 1 Wrench holder
- 8 Tool holder with vertical end
- 1 Screwdriver holder
- 6 Double tool holder
- 1 Drill holder
- 2 Pliers holder
- 2 Saw holder
- 1 Machine holder

NEW

	Anthracite	Aluminium-coloured
Assortment contents	82483	82483
28 pieces	305	105



Assortment, 35 pieces

- 5 Tool holder with angled end
- 5 Tool holder with vertical end
- 10 Double tool holder
- 15 Tool clamps

NEW

	Anthracite	Aluminium-coloured
Assortment contents	82483	82483
35 pieces	311	111

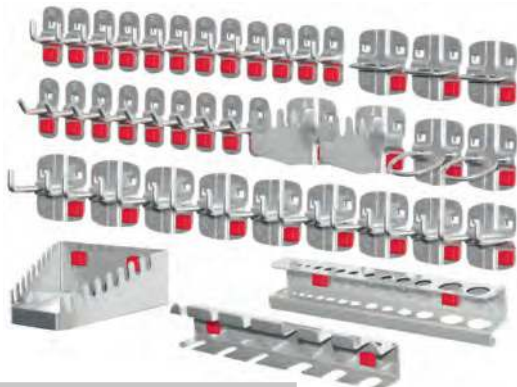

Assortment, 40 pieces

- 9 Tool holder with angled end
- 1 Wrench holder
- 12 Tool holder with vertical end
- 1 Screwdriver holder
- 9 Double tool holder
- 1 Drill holder
- 3 Pliers holder
- 2 Saw holder
- 2 Machine holder

NEW

	Anthracite	Aluminium-coloured
Assortment contents	82483	82483
40 pieces	306	106

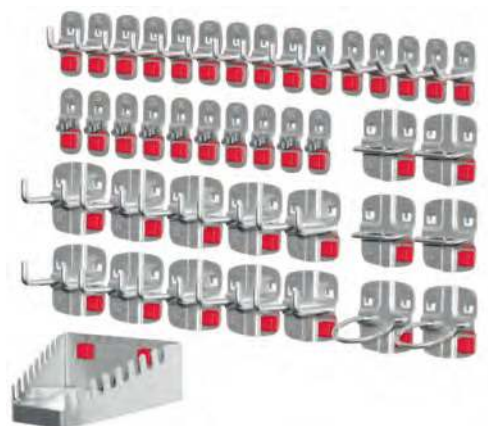

Assortment, 42 pieces

- 5 Tool holder with angled end
- 2 Machine holder
- 10 Tool holder with vertical end
- 4 Pliers holder
- 10 Double tool holder
- 1 Wrench holder
- 10 Tool clamps

NEW

	Anthracite	Aluminium-coloured
Assortment contents	82483	82483
42 pieces	312	112

Factory equipment

82484

Starter sets for perforated plates RasterPlan powered by ABAX®

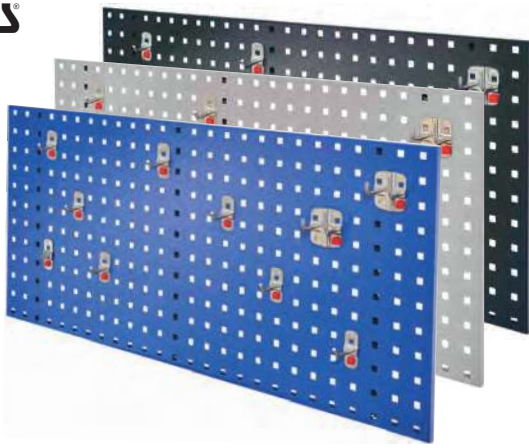
KAPPES**NEW****Equipment®RasterPlan/ABAX® starter set 1**

- 1x Perforated plate, height x width 450 x 1000 mm
- 1x Tool holder assortment, 10 pieces

	Anthracite	Light grey	Gentian blue	
Starter set 1	82484	... 82484	... 82484	...
11 pieces		103	203	303

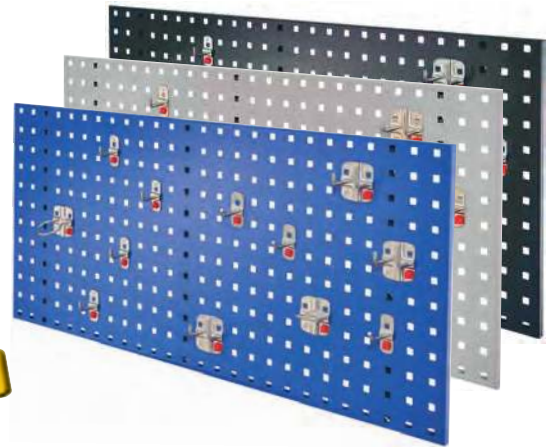
**NEW****Equipment®RasterPlan/ABAX® starter set 2**

- 1x Perforated plate, height x width 450 x 1000 mm
- 1x Tool holder assortment, 12 pieces

	Anthracite	Light grey	Gentian blue	
Starter set 2	82484	... 82484	... 82484	...
13 pieces		104	204	304

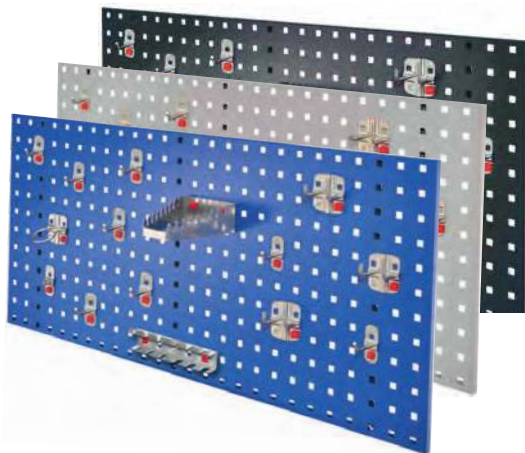
**NEW****Equipment®RasterPlan/ABAX® starter set 5**

- 1x Perforated plate, height x width 450 x 1000 mm
- 1x Tool holder assortment, 15 pieces

	Anthracite	Light grey	Gentian blue	
Starter set 5	82484	... 82484	... 82484	...
16 pieces		101	201	301

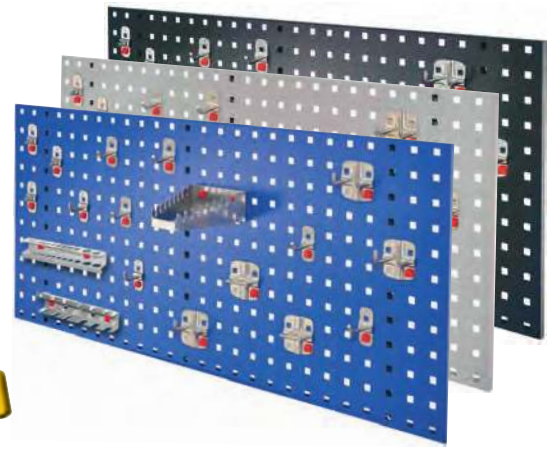
**NEW****Equipment®RasterPlan/ABAX® starter set 6**

- 1x Perforated plate, height x width 450 x 1000 mm
- 1x Tool holder assortment, 18 pieces

	Anthracite	Light grey	Gentian blue	
Starter set 6	82484	... 82484	... 82484	...
19 pieces		102	202	302

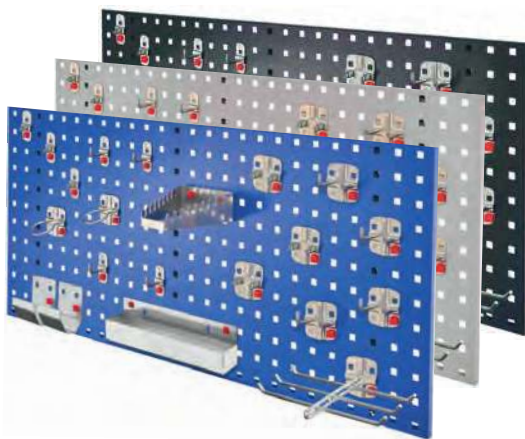
**NEW****Equipment®RasterPlan/ABAX® starter set 7**

- 1x Perforated plate, height x width 450 x 1000 mm
- 1x Tool holder assortment, 21 pieces

	Anthracite	Light grey	Gentian blue	
Starter set 7	82484	... 82484	... 82484	...
22 pieces		105	205	305

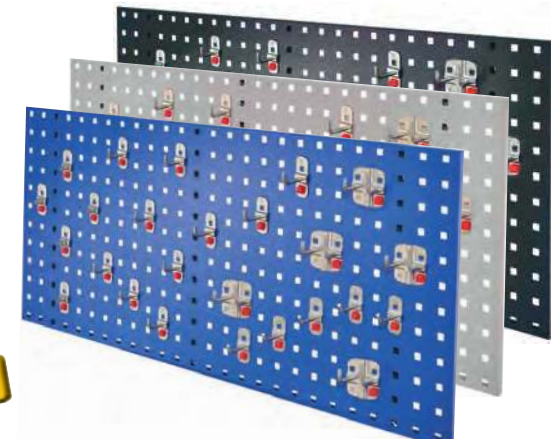
**NEW****Equipment®RasterPlan/ABAX® starter set 8**

- 1x Perforated plate, height x width 450 x 1000 mm
- 1x Tool holder assortment, 25 pieces

	Anthracite	Light grey	Gentian blue	
Starter set 8	82484	... 82484	... 82484	...
26 pieces		106	206	306

Factory equipment

KAPPES

Design

Systematic method to achieve tidiness with original RasterPlan slotted plates. **A fundamental element of the RasterPlan system.** Universal holders, easy-view storage bins, steel shelves and many other holders can be hooked into the stamped perforation of the slotted plates easily and at any time. RasterPlan slotted plates can be combined and used universally, on walls, as backs of workbenches, in partition walls, trolleys, even installed in cabinets, all in a single system.

- Clearly arranged tool storage
- Fast access
- Systematic and colour-based organisation
- For HHW easy-view storage bins size 5 - 8
- Impact-resistant and scratch-resistant plastic coating
- Specially shaped beams
- Sheet steel 1.25 mm
- Concealed screw holes
- 4 brilliant colours
- 7 sizes, 7 applications
- Compatible with RasterPlan perforated plates



Structure of the rear:
RasterPlan slotted plates are braced at the rear with specially shaped trusses, double-sided spot welded, for maximum loading.

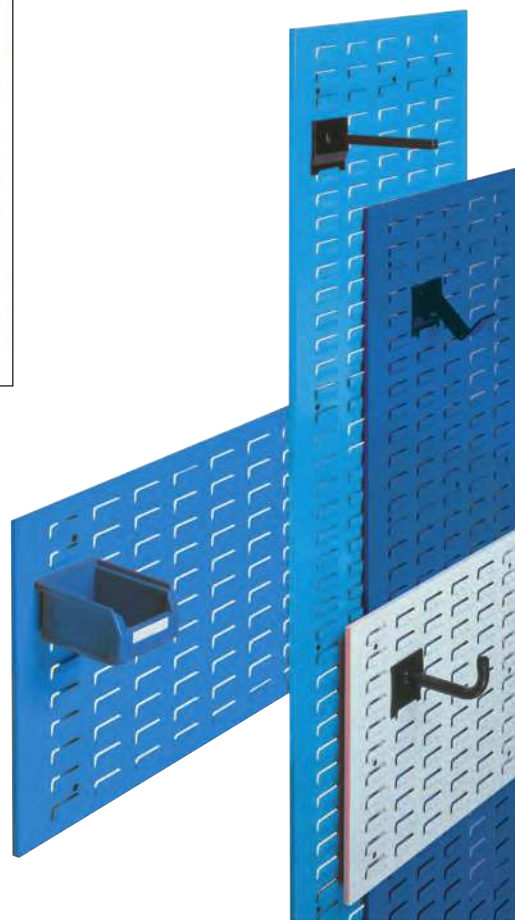

82482 201-406

Design

Wide format.

82482 501-806

Design

Portrait format.

Dimensions W x H mm	500x450	1000x450	1500x450	2000x450	450x1000	450x1500	450x2000
Plate colour	82482	... 82482	... 82482	... 82482	... 82482	... 82482	... 82482
RAL							
5012 light blue	301	401	201	210	801	501	701
5015 sky blue	302	402	202	211	802	502	702
5010 gentian blue	303	403	203	212	803	503	703
7035 light grey	306	406	206	215	806	506	706

Info

Open-fronted storage bins for slotted panels



The special construction of the suspension bar allows the open-fronted storage bins to be hung up and down absolutely horizontally even when they are filled. So no more spillage of the stored goods.

See catalogue pages 83.1 and 83.2 for open-fronted storage bins.



Horizontal



Vertical



Snap in and ready

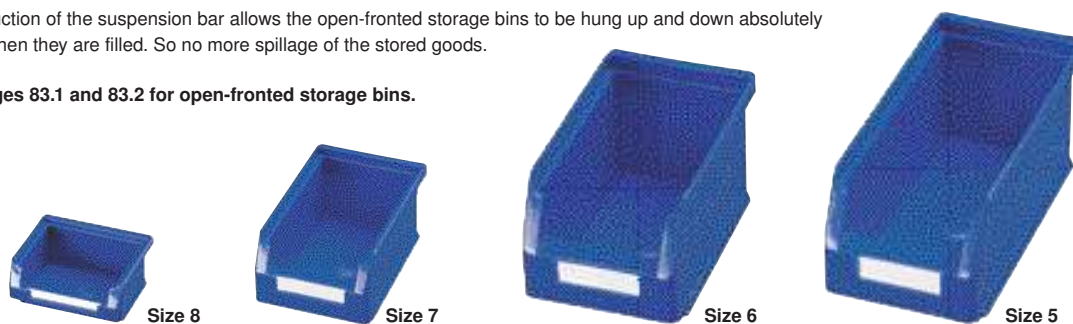

Size	Length x Width x Height ca. mm	Red		Blue		Grey		Green		Yellow	
		83401	...	83402	...	83403	...	83404	...	83405	...
8	85 x 105 x 45	101		101		101		101		101	
7	160 x 105 x 75	102		102		102		102		102	
6	230 x 140 x 130	103		103		103		103		103	
5	290 x 140 x 130	104		104		104		104		104	

Factory equipment

KAPPEL**Applications**

For hooking into the slotted plate of the RasterPlan system. Universal holders, easy-view storage bins, steel shelves and form holders etc. can be hooked into the stamped perforation of the slotted plates easily and at any time. Robust and stable, designed for long-lasting industrial use.

- Impact-resistant and scratch-resistant plastic coating
- Embossed base plate 1.5 mm thick
- High load capacity



82485 101-102

82485 103-104

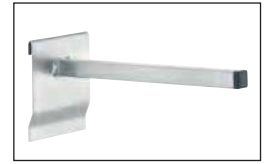
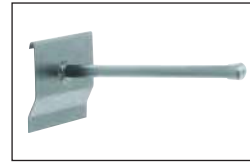

82485 105

82485 106

82485 107

82485 108

82485 109

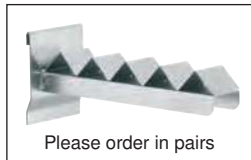

82485 113

82485 114

82485 115

82485 116

82485 117

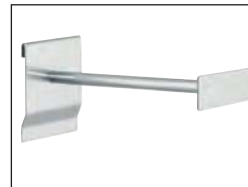

	Size mm	Ø mm	Pack= pieces	82485	...
Universal holder round load capacity 10 kg	200	12	1	101	
Universal holder round load capacity 10 kg	300	12	1	102	
Universal holder square load capacity 17 kg	200	15 x 15	1	103	
Universal holder square load capacity 17 kg	300	15 x 15	1	104	
Wave-form holder, wave spacing 55 mm load capacity 17 kg	200	-	1	105	
Spike holder load capacity 17 kg	140 x 60	-	1	106	
Pipe holder load capacity 17 kg	160	20	1	107	
Steel shelf RAL 7035	500 x 250	-	1	108	
Steel shelf RAL 7035	1000 x 250	-	1	109	
Base plate with labelling field	-	-	1	113	
Adapter for perforated-plate tool holder	-	-	1	114	
Universal holder with labelling field load capacity 10 kg	200	12	1	115	
Form holder DIN A4, RAL 7035 light grey	-	-	1	116	
Brochure holder DIN A4, RAL 7035 light grey	-	-	1	117	
Brochure holder DIN A3, RAL 7035 light grey	-	-	1	118	

82485 118

**KAPPEL****Design**

Ready-to-use starter packs relieve you of initial decisions and help to create and maintain order.

Note:

Easy-view storage bins sorted by colour, from stock, colour illustration non-binding.

82470 101+201**Design**

Comprising:

- 1 slotted plate H 450 x W 1000 mm
- 6 easy-view storage bins size 6
- 16 easy-view storage bins size 7
- 8 easy-view storage bins size 8

82470 102+202**Design**

Comprising:

- 1 slotted plate H 450 x W 500 mm
- 8 easy-view storage bins size 7
- 12 easy-view storage bins size 8



82470 101+201



82470 102+202

Dimensions H x W mm	Plate colour	82470	...
450 x 1000	RAL 7035 light grey	101	
450 x 1000	RAL 5012 light blue	201	
450 x 500	RAL 7035 light grey	102	
450 x 500	RAL 5012 light blue	202	

82470

RasterPlan combination plates

RasterPlan
von Kappes



KAPPES

Design

2/3 perforated and 1/3 slotted plate.

Note:

For an extensive range of accessories for perforated and slotted plates, see art. no. 82471, 82480, 82481, 82485 and 82467.

82470 403+401

Starter sets

Comprising:

- 1 combination plate
- 12 easy-view storage bins size 7
- 4 easy-view storage bins size 8
- 1 tool holder assortment, 10 pieces

Dimensions H x W mm	Plate colour	Unfilled		Starter set	
		82470	...	82470	...
450 x 1500	RAL 7035 light grey			303	403
450 x 1500	RAL 5012 light blue			301	401

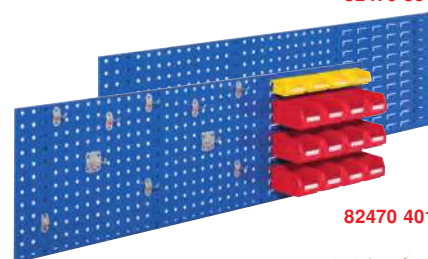

82470 301

82470 401

82467

RasterPlan workbench brackets

RasterPlan
von Kappes



KAPPES

Design

With fastening material.

Applications

For attachment to workbenches and plates one on top of the other. For plates, 2 brackets each are required. **Price per item.**

Workbench bracket For wide-format plates	82467	...
For 1 plate		101
For 2 plates one on top of the other		105



82467

82490

RasterPlan LogoChart storage

RasterPlan
von Kappes



KAPPES

Design

- Multi-functional and flexible
- Impact-resistant and scratch-resistant plastic coating
- Can be used horizontally or vertically
- H 450 x W 1000 mm, RAL 7035 light grey
- Marking area can be wiped off without a trace (do not use permanent markers)
- Magnetic

Applications

Innovative solution for setting up service rooms, storage areas, goods issuing facilities, goods receipt facilities, workshops and many other areas.

The smooth board surface is ideal for sketches, brainstorming, planning, instructions, drawings and other visualisations directly at workstations.

Unique combination of proven whiteboard and perforated plate, which adapts seamlessly to existing RasterPlan systems.

Note:

For an extensive range of perforated-plate accessories, see art. no. 82471, 82480 and 82481.



	82490 101	82490 102	82490 103
	Set 1	Set 2	Set 3
1 LogoChart	x	x	x
2 double tool holders	x	x	x
2 tool holders, angled end	x	x	x
2 tool clamps	x	x	x
1 magnetic holder	x	-	-
1 combination holder	x	x	x
1 storage box	x	-	-
1 note box	-	x	-
1 dispenser holder	-	-	x
5 magnets	x	x	x
1 wiper, magnetic	x	x	x
1 cleaning spray	x	x	x
2 non-permanent markers, black	x	x	x



LogoChart storage	82490	...
Set 1		101
Set 2		102
Set 3		103

		Accessories				
	Width mm	Height x depth mm	Ø mm	Colour	82490	...
Spray-bottle holder	76	-	1 x 52	Aluminium-cooured		201
Pen holder	112	-	4 x 17	Aluminium-coloured		202
Comb. holder for pens+spray bottle	176	-	4 x 17/1 x 52	Aluminium-coloured		203
Storage box	250	35 x 80	-	Aluminium-coloured		204

82486 - 82487

RasterPlan wall rails (empty)

RasterPlan
von Kappes



KAPPES

Note:

For accessories for perforated and slotted plates, see art. no. 82471, 82480, 82481, 82485 and 82467.

Dimensions length x height mm	Plate colour	Perforated plate		Slotted plate	
		82486	...	82487	...
460 x 70	RAL 7035 light grey			101	
920 x 70	RAL 7035 light grey			201	
460 x 100	RAL 7035 light grey				101
460 x 100	RAL 5012 light blue				102
920 x 100	RAL 7035 light grey				201
920 x 100	RAL 5012 light blue				202

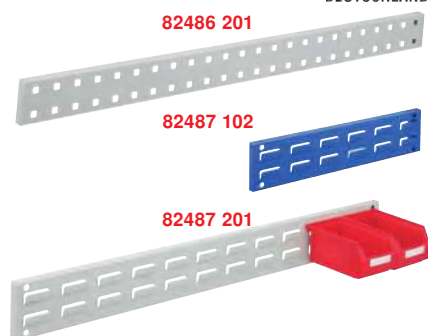

82486 201

82487 102

82487 201

KAPPES

Design

- RasterPlan drawer cabinets for professional, practical storage and organisation of high-quality tools and materials
- With drawers (100 mm panel height) and integrated worktop or multiplex workbench top panels (30 mm thick) equipped individually
- **H x W x D 1950 x 1000 x 600 mm**
- Robust sheet steel construction
- Impact-resistant and scratch-resistant plastic coating
- Body RAL 7035 light grey
- Doors either RAL 5012 light blue or RAL 7035 light grey
- Rear wall with RasterPlan system perforation or slot stamping
- Smooth fronts with pre-assembled doors
- Door opening angle over 200°
- Continuous rod guiding

- Double-walled, reinforced doors
- Telescopically guided drawers with full extension, can also be retrofitted on request
- Drawer load capacity 110 kg with evenly distributed load
- Zinc-plated shelves, load capacity 80 kg with evenly distributed load
- Shelves adjustable in 25 mm grid
- Three-bar security cylinder lock

Note:

Wall or floor anchoring is recommended.
For additional drawers, shelves and workbench top panels, see art. no. 82556 599-609.

Model	Shelves quantity	Drawers quantity	Workbench top panels quantity
1	3	2	-
3	1	4	1
4	2	4	-
5	2	3	-
6	2	2	1
7	-	9	1

Model: 1



Model: 3



Model: 4



Model: 5



Model: 6



Model: 7



82556 599



82556 603



82556 600



82556 604



Factory equipment

Model	Perforated plate doors		Slotted plate doors				Doors with viewing window			
	RAL 7035/5012	RAL 7035	RAL 7035/5012	RAL 7035	RAL 7035/5012	RAL 7035	RAL 7035/5012	RAL 7035		
	82555	...	82555	...	82555	...	82555	...	82555	...
1		102		202		100		201		701
3		106		206		105		205		702
4		101		208		112		212		703
5		107		209		110		213		704
6		108		210		111		214		705
7		104		204		103		219		706

Accessories	RAL 5012		RAL 7035	
	82556	...	82556	...
Drawer 100 mm panel height			600	599
Drawer 125 mm panel height			606	607
Drawer 175 mm panel height			608	609
Zinc-plated shelf, load capacity 80 kg with evenly distributed load				603
Multiplex workbench top panel, 30 mm thick				604

The flexible CLIP-O-FLEX hook-in system is available on its own (hook-in rail and hook-in profile) and also as part of a storage compartment/drawer or in combination with tool trolleys, workbenches, serving trolleys etc.

You can secure or release your work surface/storage area or your existing organisation system in a single hooking action.

You can make your workplace ergonomic with various angles of inclination 0/40/80° or 0/45/90° - or use lateral movement options.

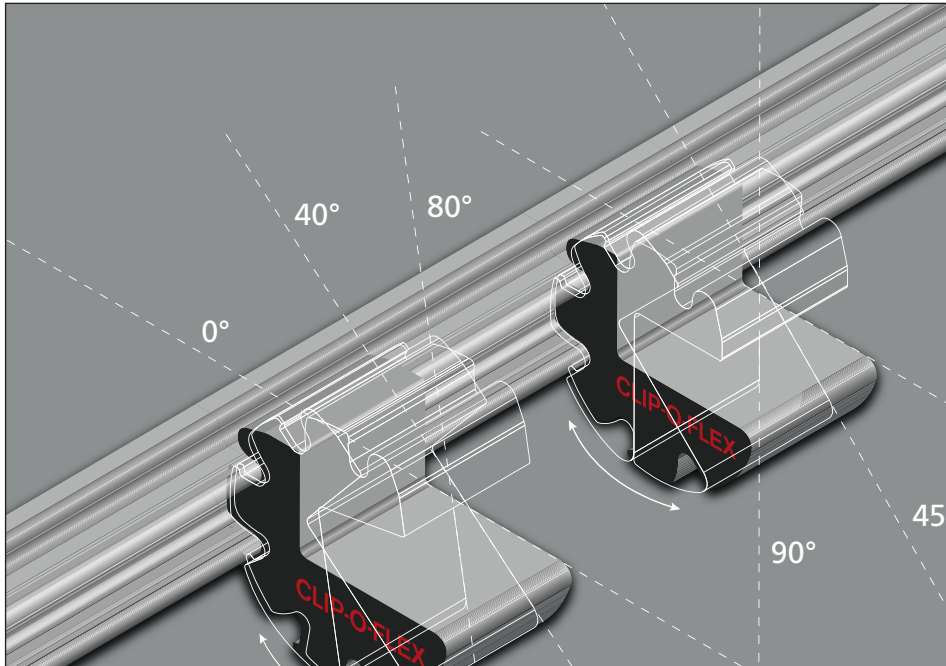

CLIP-O-FLEX fixes your work surface/storage area or your organisation system using only one clip yet with the highest level of horizontal and vertical flexibility!



The flexible hook-in profile allows variable suspension or hooking configurations at angles of 0/40/80° or 0/45/90° and lateral movement at all times.

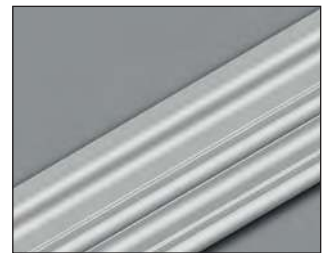

The robust hook-in rail is made of aluminium and is very lightweight, durable and stylish.



Lateral movement possible.



Prefabricated trays in various sizes, e.g. in combination with a hard foam insert or as a storage area.



Order the hook-in rail and hook-in profile individually and customise your own individual and flexible components, work surfaces or storage areas.

The benefits of CLIP-O-FLEX!

- Fast access to work equipment
- Flexible workstation design
- Excellent clarity
- Quick exchange and replacement
- Ergonomic workstation design
- Quick retrofitting
- Cutting down on travel paths
- Optimum work surface utilisation without loss

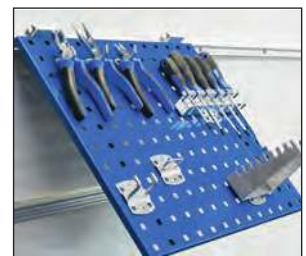

Determine angle, attach clip and your work surface/storage area is secured. Possible tilt angles 0/40/80° or 0/45/90°.

82373

CLIP-O-FLEX hook-in rails

82373

Design

- Total length = nominal length + 5 mm cover caps
- Pre-drilled
- The scope of delivery includes cover caps, plus fastening material

Applications

For mounting on RasterPlan perforated walls (centre-to-centre distance 38 mm), workbenches, tool trolleys, wall/workbench superstructures. As a holder for CLIP-O-FLEX hook-in profiles and trays.

Quality

Aluminium, natural anodised.



Length mm	Cover caps colour	82373	...
495	Black		101
695	Black		102
745	Black		103

Length mm	Cover caps colour	82373	...
795	Black		104
985	Black		105
1400	Black		106

Length mm	Cover caps colour	82373	...
1495	Black		107
1995	Black		108

82374

CLIP-O-FLEX hook-in profiles

82374

Design

- 3 x Ø 4.1 mm drilled or, alternatively, with M5 thread
- Pre-drilled
- Drilling template included

Applications

For attachment to CLIP-O-FLEX hook-in rails. Different materials can be glued, bolted or riveted to the hook-in profiles.

Quality

Aluminium, natural anodised.

Note:

Packing unit (pack) 2 pieces.
Price per pack.



Hook-in angle degrees	Width mm	Cover caps colour	Pack (pieces)	Hole	M5 thread
				82374	82374
0/40/80°	50	Black	2		101
0/45/90°	50	Black	2		201

82375

CLIP-O-FLEX plastic corner elements

82375

Applications

For attachment onto hook-in rails. For connecting two hook-in rails for use at a 90° angle, for instance on a workbench top panel.

Quality

Plastic.

Note:

Packing unit (pack) 4 pieces.
Price per pack.



Colour	Pack (pieces)	82375	...
Black	4		101

82376

CLIP-O-FLEX plastic cover caps

82376

Design

- With engaging mechanism

Applications

For attachment onto hook-in rails.

Quality

Plastic.

Note:

Packing unit (pack) 10 pieces.
Price per pack.



Dimension mm	Colour	Pack (pieces)	82376	...
2.5	Black	10		101

CLIP-O-FLEX hook-in system

82377

CLIP-O-FLEX trays

Design

- Includes 2 hook-in profiles 0/40/80° or 0/45/90°
- Powder coating: RAL 9006 white aluminium

Applications

For hooking into CLIP-O-FLEX hook-in rails at different angles. For mobile use and flexible workstation design.

Quality

Sheet steel.

Note:

Trays can be combined with OPT-I-STORE hard foam inserts (see art. no. 59603 - 59692).

82377



L x W x H Mm	Suitable TCS insert size	0/40/80°		0/45/90°	
		82377	...	82377	...
345 x 260 x 30	1/2		101		
345 x 260 x 30	1/2				201
260 x 345 x 30	1/2		102		
260 x 345 x 30	1/2				202
520 x 345 x 30	2/2		103		
520 x 345 x 30	2/2				203

82378

CLIP-O-FLEX workbenches

Design

Workbench comprising:

- Multiplex worktop
- Cabinet
- Base
- Workbench superstructure (only end no. 102, 103, 202 and 203)

Multiplex worktop

- Painted 40 x 1500 x 750 mm
- Right, left and front with bolted-on CLIP-O-FLEX hook-in rails

Cabinet

- 2 x drawers with full extension, front height of 90 mm, load capacity 35 kg
- 6 x landscape trays, each with 2 CLIP-O-FLEX hook-in profiles 0/40/80°
- 1 x door H = 540 mm, hinged on the left
- Cabinet can be locked via central lock
- Colour of housing: RAL 9006 white aluminium
- Colour of drawers/front: RAL 9005 jet black
- H x W x D = 840 x 1500 x 750 mm

Base

- 1 x base H x D = 800 x 680 mm
- Made from robust U-profile steel
- 80 x 50 x 2.0 mm with cross-bracing
- Base without level adjustment
- 1 x trim with cross brace

82378 101-103

Design

- 6 pairs of fixed support brackets for CLIP-O-FLEX trays

82378 201-203

Design

- 6 pairs of extension systems for CLIP-O-FLEX trays

With fixed support bracket



Trays can be easily placed on the support bracket.

Extension system



The convenient extensions allow easy removal and insertion of the trays by also pulling out the rail.

82378



The undercounter cabinet is equipped with 6 CLIP-O-FLEX trays. These can be easily removed and stowed away neatly and clearly in the undercounter cabinet again after use.



Trays can be fitted anywhere at the side of the workbench. Tools and other material do not require space on the workbench top panel.

Workbench superstructure height mm	Workbench superstructure	Fixed support brackets for trays		Extensions for trays	
		82378	...	82378	...
-	Without		101		
-	Without				201
470	Included		102		
470	Included				202
820	Included		103		
820	Included				203

Factory equipment

Design

- Right and left on cover with bolted-on CLIP-O-FLEX hook-in rails
- Incl. 30 mm multiplex top panel varnished
- 1 x steering roller with stop
- 1 x steering roller without stop
- 2 x fixed castors Ø 125 mm
- Colour of housing: RAL 9006 white aluminium
- Colour of drawers/front: RAL 9005 jet black

Cabinet equipped with:

- 6 x landscape trays, each with 2 CLIP-O-FLEX hook-in profiles 0/40/80°
- 1 x door, hinged on the right
- Cabinet can be locked via central lock

82379 101**Design**

- 6 pairs of fixed support brackets for CLIP-O-FLEX trays

82379 201**Design**

- 6 pairs of extension systems for CLIP-O-FLEX trays

Fixed support brackets

Trays can be easily placed on the support brackets.

Extension systems

The convenient extensions allow easy removal and insertion of the trays by also pulling out the rail.



Includes 6 trays, each with 2 CLIP-O-FLEX hook-in profiles 0/40/80°

H x W x D mm	Trays W x D x H mm	Door height mm	Weight kg	Fixed support brackets for trays		Extensions for trays	
				82379	...	82379	...
778 x 474 x 405	345 x 260 x 30	540	50			101	
778 x 474 x 405	345 x 260 x 30	540	59				201

Design

- Right and left on cover with bolted-on CLIP-O-FLEX hook-in rails
- Incl. 30 mm multiplex top panel varnished
- 1 x steering roller with stop
- 1 x steering roller without stop
- 2 x fixed castors Ø 125 mm
- Colour of housing: RAL 9006 white aluminium
- Colour of drawers/front: RAL 9006 jet black

Fixed support brackets

Trays can be easily placed on the support brackets.

Extension system

The convenient extensions allow easy removal and insertion of the trays by also pulling out the rail.

82380 101+201**Cabinet equipped with:**

- 2 x drawers with full extension
- 6 x landscape trays, each with 2 CLIP-O-FLEX hook-in profiles 0/40/80°
- 1 x door, hinged on the right
- Cabinet can be locked via central lock

82380 101**Design**

- 6 pairs of fixed support brackets for CLIP-O-FLEX trays

82380 201**Design**

- 6 pairs of extension systems for CLIP-O-FLEX trays

82380 102+202**Cabinet equipped with:**

- 8 x landscape trays, each with 2 CLIP-O-FLEX hook-in profiles 0/40/80°
- 1 x door, hinged on the right
- Cabinet can be locked via central lock

82380 102**Design**

- 8 pairs of fixed support brackets for CLIP-O-FLEX trays

82380 202**Design**

- 8 pairs of extension systems for CLIP-O-FLEX trays

82380 101+201

2 drawers with full extension, front height of 90 mm, load capacity 35 kg
6 trays, each with 2 CLIP-O-FLEX hook-in profiles 0/40/80°

82380 102+202

Includes 8 trays, each with 2 CLIP-O-FLEX hook-in rails 0/40/80°

H x W x D mm	Trays W x D x H mm	Door height mm	Drawers front height mm	Drawers load capacity kg	Weight kg	Fixed support brackets for trays		Extensions for trays	
						82380	...	82380	...
958 x 474 x 405	345 x 260 x 30	540	90	35	69			101	
958 x 474 x 405	345 x 260 x 30	540	90	35	78				201
958 x 474 x 405	345 x 260 x 30	720	-	-	62			102	
958 x 474 x 405	345 x 260 x 30	720	-	-	71				202

82381

CLIP-O-FLEX wheeled workbenches

Design

- Right and left on cover with bolted-on CLIP-O-FLEX hook-in rails
- Incl. 30 mm multiplex top panel varnished
- 1 x steering roller with stop
- 1 x steering roller without stop
- 2 x fixed castors Ø 125 mm
- Colour of housing: RAL 9006 white aluminium
- Colour of drawers/front: RAL 9005 jet black

Left cabinet equipped with:

- 2 x drawers with full extension
- 6 x landscape trays, each with 2 CLIP-O-FLEX hook-in profiles 0/40/80°
- 1 x door, hinged on the left
- Cabinet can be locked via central lock

Right cabinet equipped with:

- 2 x drawers with full extension
- 6 x landscape trays, each with 2 CLIP-O-FLEX hook-in profiles 0/40/80°
- 1 x door, hinged on the right
- Cabinet can be locked via central lock

82381 142

Design

- 12 pairs of fixed support brackets for CLIP-O-FLEX trays

82381 143

Design

- 12 pairs of extension systems for CLIP-O-FLEX trays

Fixed support brackets



Trays can be easily placed on the support brackets.

Extension system



The convenient extensions allow easy removal and insertion of the trays by also pulling out the rail.

82381



2 drawers with full extension, front height of 90 mm, load capacity 35 kg
Includes 6 trays, each with 2 CLIP-O-FLEX hook-in profiles 0/40/80°

H x W x D mm	Trays W x D x H mm	Door height mm	Drawers front height mm	Drawers load capacity kg	Weight kg	Fixed support brackets for trays		Extensions for trays	
						82381	...	82381	...
958 x 953 x 405	345 x 260 x 30	540	90	35	125			142	
958 x 953 x 405	345 x 260 x 30	540	90	35	136				143

82382

CLIP-O-FLEX wheeled workbenches

Design

- Right and left on cover with bolted-on CLIP-O-FLEX hook-in rails
- Incl. 30 mm multiplex top panel varnished
- 1 x steering roller with stop
- 1 x steering roller without stop
- 2 x fixed castors Ø 125 mm
- Colour of housing: RAL 9006 white aluminium
- Colour of drawers/front: RAL 9005 jet black

Left cabinet equipped with:

- 2 x drawers with full extension
- 6 x landscape trays, each with 2 CLIP-O-FLEX hook-in profiles 0/40/80°
- 1 x door = H 540 mm, hinged on the left
- Cabinet can be locked via central lock

Right cabinet equipped with:

- 8 x landscape trays, each with 2 CLIP-O-FLEX hook-in profiles 0/40/80°
- 1 x door = H 720 mm, hinged on the right
- Cabinet can be locked via central lock

82382 101

Design

- 14 pairs of fixed support brackets for CLIP-O-FLEX trays

82382 201

Design

- 14 pairs of extension systems for CLIP-O-FLEX trays

Fixed support brackets



Trays can be easily placed on the support brackets.

Extension system



The convenient extensions allow easy removal and insertion of the trays by also pulling out the rail.

82382



2 drawers, full extension, front height of 90 mm, load capacity 35 kg
Includes 6 trays, each with 2 CLIP-O-FLEX hook-in profiles 0/40/80°
Includes 8 trays, each with 2 CLIP-O-FLEX hook-in profiles 0/40/80°

H x W x D mm	Trays W x D x H mm	Drawers front height mm	Drawers load capacity kg	Weight kg	Fixed support brackets for trays		Extensions for trays	
					82382	...	82382	...
958 x 953 x 405	345 x 260 x 30	90	35	119			101	
958 x 953 x 405	345 x 260 x 30	90	35	129				201

Factory equipment

KAPPES**Design**

- Solid frame construction RAL 5010 gentian blue
- Powder-coated perforated plates on 4 sides RAL 7035 light grey
- Hole spacing: 38 mm
- Square perforation 10 x 10 mm

Applications

For equipping with RasterPlan tool holder range and RasterPlan accessories. For the systematic and central storing and provisioning of tools, small parts and organisation materials.

Note:

Delivery without accessories and without decoration!
Optional additional mobile versions are available with additional usable interior space with further perforated plates, shelves and door with cylinder lock and 2 keys.

RasterPlan
von Kappes

**82388 101-105****ToolTower, stationary****Design**

- 4 RasterPlan perforated plates



Art. no. 82388 ...	101	102	103	104	105
H x W x D mm	1100 x 700 x 700	2015 x 700 x 700	2015 x 700 x 700	2015 x 700 x 700	2015 x 700 x 700
Equipment	3 x perforated plates	4 x perforated plates	3 x perforated plates	3 x perforated plates	3 x perforated plates
Stationary	1 x perforated plate door	3 x trays	1 x perforated plate door	1 x perforated plate door	1 x perforated plate door
	1 x form holder DIN A4	1 x hook set	3 x trays	2 x trays	1 x form holder DIN A4
	1 x combination holder			1 x shelf	2 x shelf
				1 x dispenser holder	1 x hook set
				1 x hook set	

82388 201-205**ToolTower, mobile****Design**

- 4 RasterPlan perforated plates
- Chassis with 4 steering rollers, 2 of which have a locking device



Art. no. 82388 ...	201	202	203	204	205
H x W x D mm	1260 x 700 x 700	2175 x 700 x 700	2175 x 700 x 700	2175 x 700 x 700	2175 x 700 x 700
Equipment	3 x perforated plates	4 x perforated plates	3 x perforated plates	3 x perforated plates	3 x perforated plates
Mobile	1 x perforated plate door	3 x trays	1 x perforated plate door	1 x perforated plate door	1 x perforated plate door
	1 x form holder DIN A4	1 x hook set	3 x trays	3 x trays	3 x trays
	1 x combination holder	4 x steering rollers, 2 of which have locking device	1 x hook set	4 x steering rollers, 2 of which have locking device	1 x shelf
	4 x steering rollers, 2 of which have locking device		1 x shelf		4 x steering rollers, 2 of which have locking device
			4 x steering rollers, 2 of which have locking device		

Model	82388	...	82388	...	82388	...	82388	...	82388	...
ToolTower, stationary		101		102		103		104		105
ToolTower, mobile		201		202		203		204		205